

MODEL—1896

PROM PROGRAMMER

— *OPERATION MANUAL* —

Preface

Thank you for purchasing Minato gang programmer Model-1896. Please read through this manual to best use of Model-1896. Please keep this manual in handy and refer it whenever needed.

- Contents may be changed without prior notice.
- Unapproved reproduction is prohibited.

The first edition JUNE 2006.

TABLE OF CONTENTS

TABLE OF CONTENTS	i
-------------------------	---

BEFORE USING THE PROGRAMMER

SATETY PRECAUTION	2
HOW TO READ THIS MANUAL	6
ILLUSTRATIONS FOR THE OPERATION	7
OUTLINE OF THE PRODUCT	8
STANDARD ACCESSORIES	9
INSTALLATION AND TURNING ON THE POWER	10
SELF CHECK	10
NAME AND FUNCTION OF EACH KEY	12
SOCKET UNIT	15
INSERTING A DEVICE IN A SOCKET	19
HOW TO READ DISPLAY	20
KEY OPERATION ON INITIAL DISPLAY	21

BASIC OPERATION

TO PROGRAM A DEVICE	23
SET A DEVICE CODE	24
AUTO SELECT	24
SETTING A DEVICE BY KEY OPERATION	26
COPY (Copying Device Data)	28
ERASE (Erase Data in a Device)	30
BLANK (To Check the Erase Statue of the Device Data)	32
PROG (To program Device Data)	34
VERIFY (To verify the Device Data and the Buffer Memory)	36
CONT (Continuous Mode)	39
REMARKS	42
CONTACT CHECK	42
ID CHECK	43
DISPLAY OF OPERATING TIME	44
DISPLAY OF SUM AND XOR	44

ADVANCE OPERATION MODE

ADVANCE OPERATION MODE	46
USING MENU	46
LIST OF MENU	47
PAE (Specify operating address of the device)	48
READ VCC (Change device read voltage)	55
VERIFY PATTERN (Changing the number of verify)	56

ID CHECK (Setting of ID CHECK)	57
PROTECT MODE (Setting of device data protect mode)	58
PROTECT SETTING (To change protect setting for protected data)	61
REPEAT MODE (Setting of Repeat mode)	62
SET PRG MODE (Programming different data on multiple device)	63
MONITOR MODE (Checking of NAND DEVICE setting)	67

MEMORY

LITTLE-ENDIAN MODE	69
BUFFER INIT (Initializing Buffer Memory Data)	70
BUFFER DUMP/EDIT (Dumping and editing buffer memory data)	71
BYTE SWAP (Buffer memory data byte swap)	72
WORD SWAP (Word swap of buffer memory data)	73
CHECK SUM (Calculation of add and sum)	74
CRC16/32 Calc (Calculation of CRC16/32)	75

SYSTEM

DEVCHK/BUZZER/LED Setting of Device-check, Buzzer, And LED	77
CHECKING THE FIRMWARE VERSION OF M1896	78
UPDATING THE FIRMWARE VERSION OF M1896	79
SELF CHECK MODE (Skip/No skip of self check mode)	81
SOCKET UNIT (Selecting socket unit)	82

DATA TRANSFER

DATATRANSFER	84
RS CONFIG (Setting interface configuration)	85
DATA FORMAT (Setting transfer data format)	86
SERIAL IN (Data transfer : serial input)	87
SERIAL OUT (Data transfer : serial output)	88
PROTECT SR IN (Protected data transfer : serial input)	89
PROTECT SR OUT (Protected data transfer : serial out put)	90
REMOTE CONTROL	91
IF SELECT (Selection of an interface)	92
REMOTE CONFIG (Setting the condition of remote mode)	93
EXECUTING REMOTE MODE	95

REMOTE COMMAND —COMMAND OPERATION —

CAUTION OF REMOTE OPERATION	97
HOW TO READ THIS CHAPTER	98
FORM OF REMOTE COMMAND	99

SIGNS TO BE USED IN REMOTE COMMAND	100
OUTPUT FORMS OF THE RESULTS	101
LIST OF COMMANDS	102
EXPLANATION OF THE FUNCTION	103
CTRL+E CTRL+E(Execution of remote mode)	103
E,BY (End of remote mode)	103
RMD (Setting of remote mode condition)	104
CTRL+D(Interruption of the operation)	105
H(Displaying list of help)	106
N,DV(Selecting device code)	107
OP,CP(Executing COPY)	108
Z,ER(Executing ERASE)	109
B,BL(Executiing BLANK)	110
W,PG(Executing PROG)	111
V,VF Executing VERIFY	112
OT,CT(Executing CONT)	113
CK (Device contact check)	114
SIG (Setting of ID check)	115
MD,PAE(Specifying device operating area)	116
S,DF (Setting data format for transfer)	121
BLK(Programming different data in multiple devices)	123
BS(Displaying buffer memory size)	125
REV (Displaying firmware version)	126
L,LS(Displaying buffer memory data)	127
BO,CS (Add 4 digits)	128
BO8,CS8 (Add 8 digits)	129
F,INI (Initializing buffer memory data)	130
SCH(Data searching:correspondance)	131
UNS(Data searching : un correspondance)	132
T (Transferring data)	133
P,PL,WD (Serial I/F data output)	134
RD (Serial I/F data input)	135
RL (Serial I/F data input)	136
WH (Ourput programmer model name)	137
PCH(Changing protect mode)	138
WP(Serial I/F protected data output)	139
RP (Serial I/F protect data input)	140

MAINTENANCE

ERROR MESSAGE	142
ERROR MESSAGE DURING SELF TEST	142
ERROR MESSAGE DURING OPERATION	143
ERROR MESSAGE DURING REMOTE MODE	143



AFTER SERVICE144
USER MAINTENANCE OF DEVICE PROGRAMMERS AND ADAPTERS 144

SPECIFICATION145
 SPECIFICATION OF M1896145
 SPECIFICAION OF CONNCECTOR (RS232C) 146
 SPECIFICATION OF CONNECTOR(USB)147
HEAD QUARTER148



BEFORE USING THE PROGRAMMER





Safety precaution	2
How to read this manual	6
Illustration for the operation	7
Out line of the product	8
Standard accessories	9
Installation and turning on the power	10
Self check	10
Name and function of each key	12
Socket unit	15
Inserting a device in a socket	19
How to read display	20
Key operation on initial display	21

SAFETY PRECAUTION





This operation manual describes the safety precaution of Model-1896 for our own safety.
 The following pictographs are used to prevent any injury of you and any damage on your property.
 When you operate Model-1896, Please follow the safety instruction on this manual.

◎Explanation of pictographs







 Warning	Indicates a potential hazardous situation in which the operator would be killed or seriously injured unless the precaution is observed.
 Caution	Indicates potential situation in which operator would be injured or property would be damaged unless this precaution is observed.

 Inhibit	This means "prohibited matters".
 Don't disassemble	This means "do not disassemble".
 Compulsion	This means "compulsory matters"
 Unplug Power Cord	This means "Unplug the power cable"

Warning

 Compulsion	When operating this unit, be sure to follow warnings and cautionary instructions given by Minato Electronics Inc.
 Don't disassemble	Do not disassemble or modify this unit, A fire may start or you may get an electric shock.
 Unplug Power Cord	When finding a smoke, feeling an abnormal smell or hearing an abnormal sound, pull out the power plug immediately from the AC plug receptacle. If keep operating, a fire may start or you may get an electric shock owing to short-circuit. Consult with our authorized distributor.
 Unplug Power Cord	If dropped this unit or given a strong shock to the unit, pull out the power plug immediately from the AC plug receptacle. If keep operating, a fire may start or you may get an electric shock owing to short-circuit. Consult with our authorized distributor.
 Unplug Power Cord	If any liquid or foreign matter enters this unit, pull out the power plug immediately from the AC plug receptacle. If keep operating, a fire may start or you may get an electric shock owing to short-circuit. Consult with our authorized distributor.

Caution

 Compulsion	<p>This unit shall be operated by an operator who has fully understood the operation manual of Model 1896.</p> <p>Any liquid of condensation may damage this unit or the device.</p>
 Compulsion	<p>Before touching this unit, be sure to touch a near-by metal and remove electrostatic from your body so that this unit is not damaged by electrostatic.</p> <p>Electrostatic may damage this unit and other devices.</p>
 Compulsion	<p>Do not use or leave the unit in humid or dusty area.</p> <p>It may cause an electric shock or damage the unit.</p>
 Compulsion	<p>Clean the unit surface, the device socket.</p> <p>Operation without removing dusts from them will probably result in a fire or a trouble. Try to clean them periodically.</p>
 Compulsion	<p>Do not cover the cooling fan and windows.</p> <p>It may cause a fire or damage the unit due to accumulated heat on the unit. (Refer to Name and function of each key.)</p>
 Compulsion	<p>Do not step on the unit or put any heavy items on the unit.</p> <p>It may cause an injury or damage the unit.</p>
 Compulsion	<p>Do not perform ESD to the contact on the adapter's IC sockets due to its directly connecting the internal circuit.</p> <p>Also, do not get closer within 10mm from the contact for an ESD device which has more than 2KV.</p> <p>If the above case occurred for the ESD or getting closer within 10mm, it may cause wrong operation or any breakage.</p>

 Compulsion	Do not program inserting device socket when Empty Socket (LED lump) is displayed. It may cause fever damage of units and device.
---	---

 Compulsion	Make sure that check sum if device is PASS or FAIL It may cause failed device is mixed in products.
---	--

How to read this manual

Title Overview about this page

Protect setting — To change protect setting for protected data —

In order to apply protect on a device, not only protect mode setting but also the targeted protect area should be selected. This is called "Protect data set". The protect failure of M1896 is designed to set Protect/unprotect, of each individual area. The default setting is all "un Protect".

<div style="border: 1px dashed black; padding: 2px; margin-bottom: 5px;"> MOD > ▼ Buffer operation > </div> <div style="border: 1px dashed black; padding: 2px;"> ENT > ▼ Protect setting > ENT </div> <div style="display: flex; gap: 10px;"> <div style="border: 1px solid black; padding: 2px;">◀</div> <div style="border: 1px solid black; padding: 2px;">▶</div> </div> : Change value <div style="display: flex; gap: 10px;"> <div style="border: 1px solid black; padding: 2px;">▲</div> <div style="border: 1px solid black; padding: 2px;">▼</div> </div> : Move the cursor to "(" <div style="border: 1px solid black; padding: 2px; display: inline-block;">START</div> : Enable changed value	<div style="border: 1px solid black; padding: 5px; width: fit-content; margin: 0 auto;"> <table style="border-collapse: collapse; font-family: monospace;"> <tr><td style="padding: 2px;">Protect</td><td style="padding: 2px;">[</td><td style="padding: 2px;">Total</td><td style="padding: 2px;">:</td><td style="padding: 2px;">036</td><td style="padding: 2px;">]</td></tr> <tr><td style="padding: 2px;">0</td><td style="padding: 2px;">:</td><td style="padding: 2px;">[</td><td style="padding: 2px;">Un</td><td style="padding: 2px;">Protect</td><td style="padding: 2px;">]</td></tr> <tr><td style="padding: 2px;">1</td><td style="padding: 2px;">:</td><td style="padding: 2px;">Protect</td><td colspan="3"></td></tr> <tr><td style="padding: 2px;">2</td><td style="padding: 2px;">:</td><td style="padding: 2px;">Un</td><td style="padding: 2px;">Protect</td><td colspan="2"></td></tr> </table> </div>	Protect	[Total	:	036]	0	:	[Un	Protect]	1	:	Protect				2	:	Un	Protect		
Protect	[Total	:	036]																				
0	:	[Un	Protect]																				
1	:	Protect																							
2	:	Un	Protect																						

Remarks : Above display is the select screen of "Spansion 32M S71PL032JXX".
 "0:" "1:" "2:" indicates the number of protect area."0:" means "sector 0" or "block 0" in the data sheet.
 "Protect" should be selected for the number to protect and "Un protect" should be selected for the number not to protect. On above screen,"TOTAL 36" means there are 36 of protecting area.
 When device code is changed and the power is turned on/off,the setting is changed to default value.

Warning : This area and configuration of protect is different on each device. Please check data sheet first.
 Some devices do not have this feature.
 If currency selected device does not support protect feature, "Protect not support!" is displayed on LCD.
 In order to erase protected data,"ERASE" should be executed.

Procedure to select the Menu

Procedure to change settings

Warning on operation are indicated.



















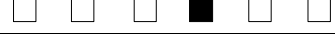











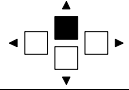

"Remarks"
 Advices on operation are indicated.
 Please be sure to read.

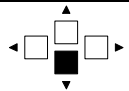
Page number

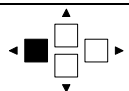
Contents at the display

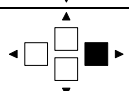
Illustrations for the operation

In this manual, the following illustrations are used to describe the operation of each key.

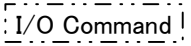
Illustration for each operation	Corresponding key	Description
		Go to the next step
	COPY ERASE BLANK PROG VERIFY CONT 	Press COPY key
	COPY ERASE BLANK PROG VERIFY CONT 	Press ERASE key
	COPY ERASE BLANK PROG VERIFY CONT 	Press BLANK key
	COPY ERASE BLANK PROG VERIFY CONT 	Press PROG key
	COPY ERASE BLANK PROG VERIFY CONT 	Press VERIFY key
	COPY ERASE BLANK PROG VERIFY CONT 	Press CONT key
	MODECOM  DEV ENT	Press MODE key
	MODECOM  DEV ENT	Press COM Key
	MODECOM  DEV ENT	Press DEV key
	MODECOM  DEV ENT	Press ENT key
		Press UP key
		Press DOWN key
		Press LEFT key
		Press RIGHT key
	RESET  START	Press START key
	RESET  START	Press RESET key
		A menu select, match the cursor"()"to the corresponding title.

Outline of the product

Model-1896(hereafter called M1896) is a gang programmer that supports various devices including high-density devices. It is equipped with 32 M bytes(256M bits) buffer memory.It can program 8pieces of devices simultaneously.

Interface to PC is available for mass production at automated production lines.You can expect high performance in your production line.

In mass production line where QC is the bottom line, M1896 accomplishes various checking right away although you might not expect it due to its high operating speed. It also lowers the yield loss, which could be caused by initial failure of the devices.

[Major features]

- Socket unit(SU816) for 8bit/16bit device is equipped.
- 8pcs MCP is programmed simultaneously.
- Buffer memory of 256Mbit is equipped as standard.
- Various device is supported.

Standard accessories

BASIC SET

■ Main Unit

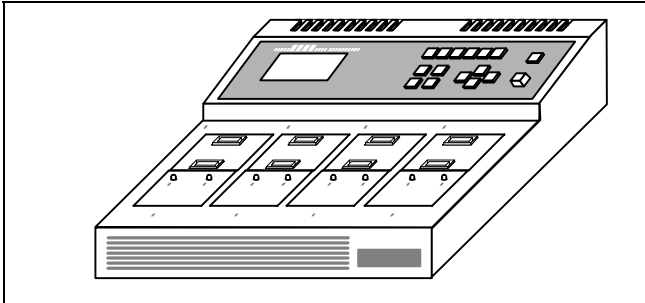

■ Power cable

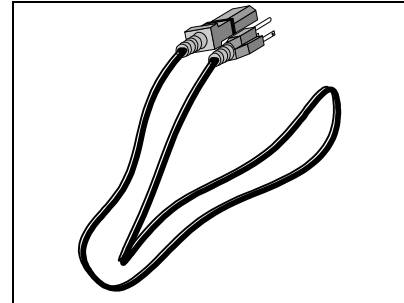

■ Socket Unit SU816

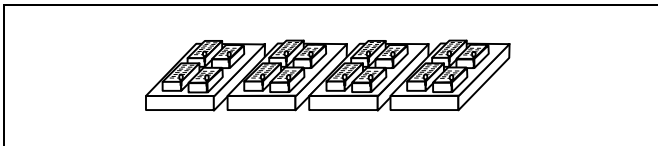

■ Compact Disc (CD)

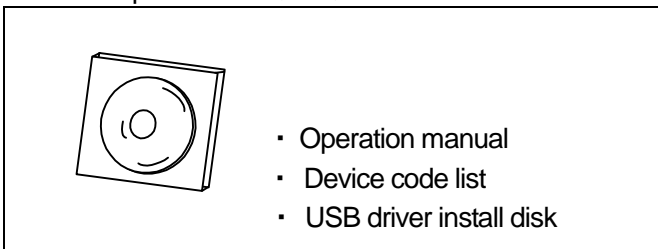

OPTIONAL SET (The type and quantity is determined by your order.)

■ Socket Unit

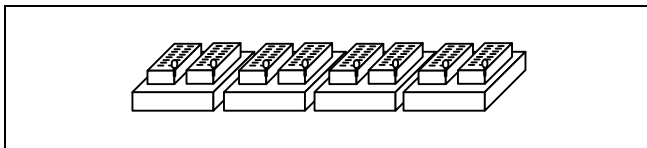

■ Conversion Adapter

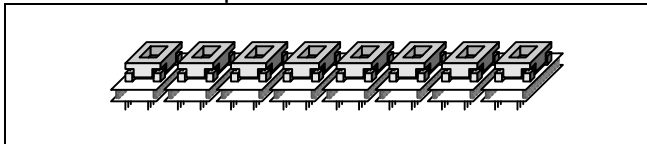

If any of them are missing or damaged, please contact to our local distributors.
We recommend keeping the original packaging for a future tams-shipment.

Installation and turning on the power

Cautions on the installing environment and power switch are described.

Caution for installing environment

- Avoid to install near an equipment which generates high noise such as motor driven machine, electric soldering machine.
- The unit must be leveled. Avoid vibration to the unit.
- AC cable should be connected to designated power source.
- Do not use multiple outlet extension plug.
- When plug in AC power cable, make sure that M1896 is switched off.

Self check

- When turning the power on, make sure that non-device are set on the socket adapters. If power is turned on with devices left on the adapters, it may damage the devices.
- After turning on the power, M1896 starts self(diagnosis)test. If the following display is appeared, the test is passed.

When ALL_PASS is displayed, everything is fine.

```
M189x Self check END
Self check ALL_PASS
Time <xx.xx.xx>
```

After a few seconds, the firmware version of the unit is displayed.

```
M1896 Ver2.30
AUG-2005
32M byte memory
```

Then self-test is completed and initial page is displayed. The last device before turning off the power is set on the programmer. Initial operation mode is "BLANK"

```
BLANK N 16bit x 1
Spansion cd:3508A0
S71PL032Jxx
SU816
```

- * When different socket unit is inserted, the default device of the base unit becomes valid.

When socket unit is not installed yet, the following message is displayed. The device code is not set yet. Install the socket unit on the programmer and set a device code.

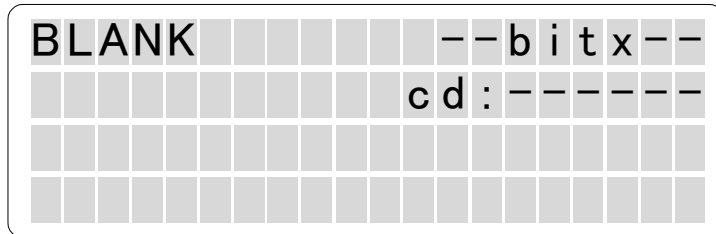

Turning off the power

When turning off the power, make sure that no device is set on an adapter. Socket unit(s) can be stayed on the programmer.

Name and function of each key

(1) Display (2) ~ (5) Setting keys (6) ~ (11) Functions keys (12) ~ (13) Arrow keys

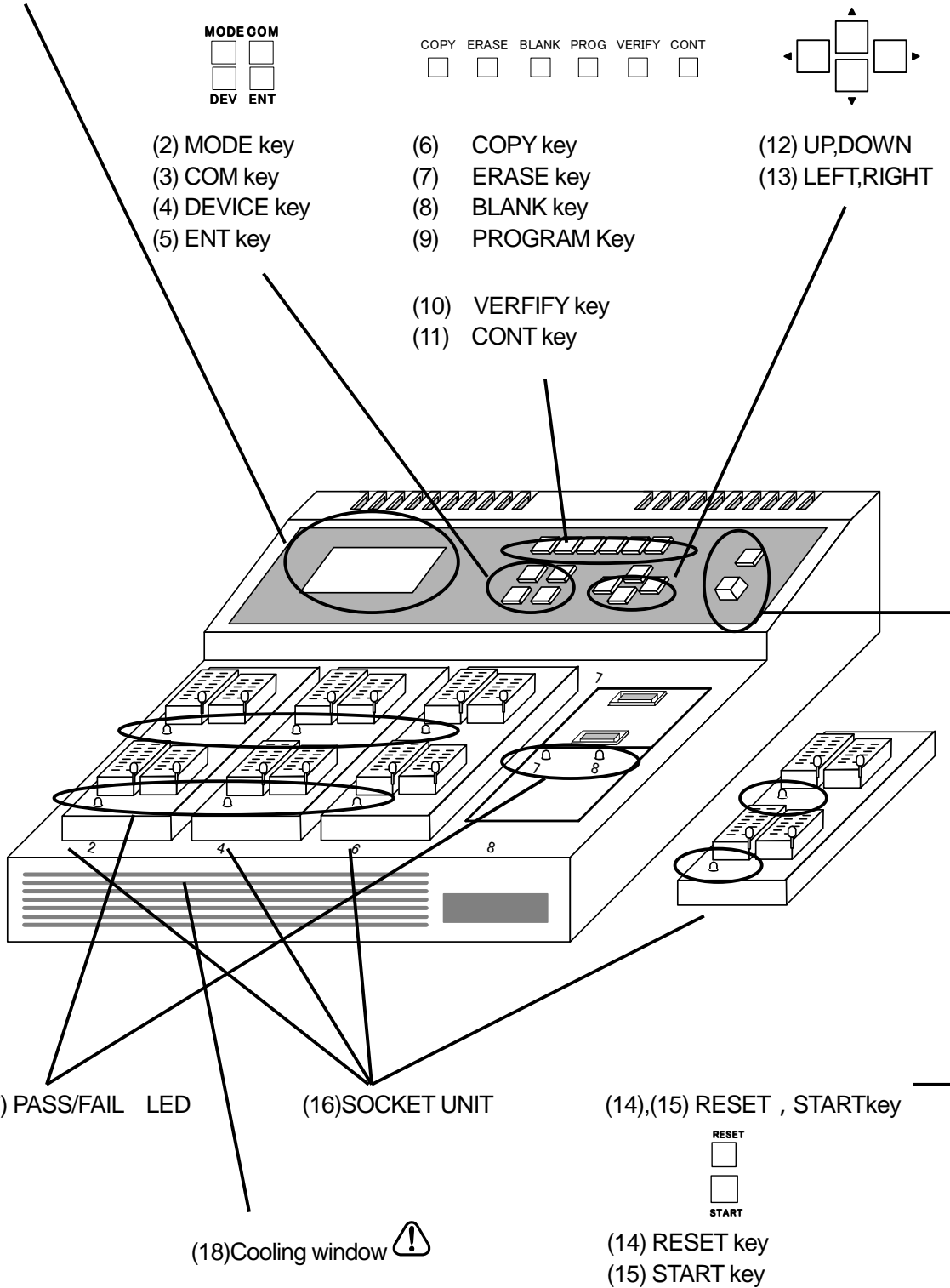

※ PASS/FAIL lamp of SU816 socket unit is equipped with itself, PASS/FAIL lamp is turned on when it is used.

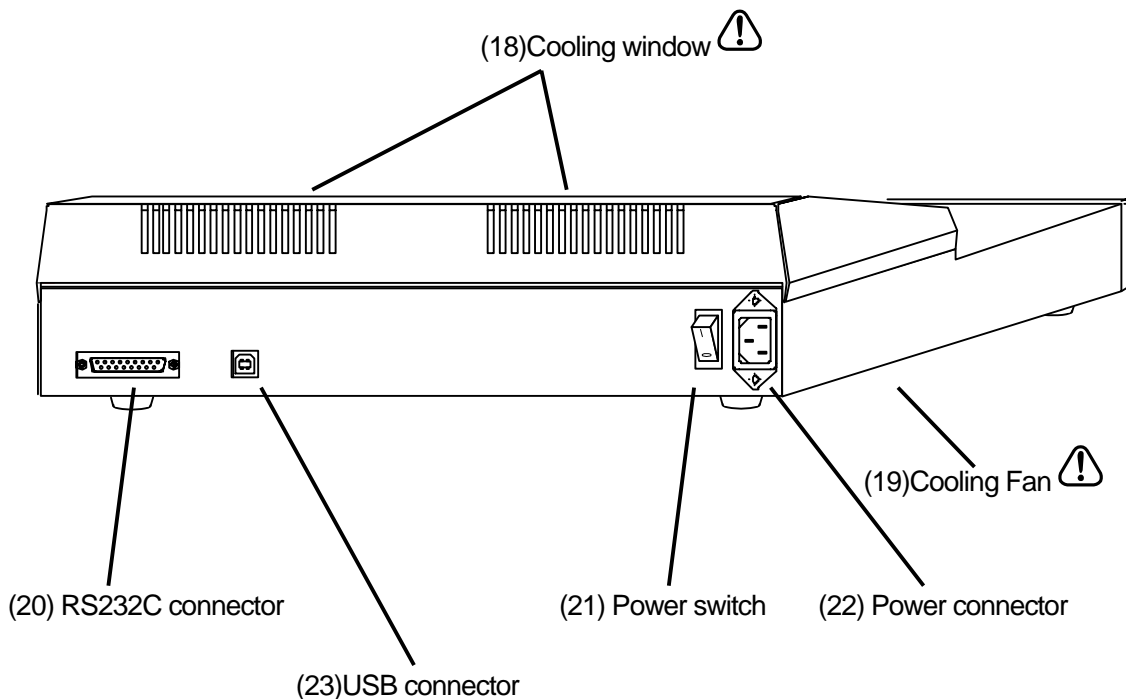

(1) LCD Display(20 × 4)

Selected device is displayed and all other functions are displayed.

(2) MODE Key

It is used for editing memory data and communicating with PC.

(3) COM key

It is used for data check, edit mode change when editing memory data.

(4) DEVICE key

it is used to set a device.

(5) ENT key

It is used to select or enter the targeted function.

■ Function keys(6)~(11)

These keys are to execute basic function of the programmer. Basic functions consists of 6types of function including “COPY”, “ERASE”, “BLANK”, “PROG (PROGRAM)”, “VERIFY”, “CONT”.Each key has designated function for easy of use.

By pressing only one of these keys does not execute the function.In order to execute the function,Start key must be hit.

(6) COPY key



Copy data in the master ROM to the buffer memory of M1896.

(7) ERASE key

Erase the data in the device.

(8) BLANK key

To check if the data in the device is blank or not.

- (9) PROG key
To program data in the device.
- (10) VERIFY key
To compare the data between the device and the buffer of M1896.
- (11) CONT(CONTINOUS MODE)key
To execute ERASE, BLANK, PROG, VERIFY sequentially.
- (12)UP and DOWN arrow key
To move cursor“[]”and to change the set value
- (13)LEFT and RIGHT arrow key
To move cursor “[]”for each function and move it other digits.
- (14) RESET key
To cancel a function
- (15) START key
To execute COPY,PROG and to fix a new setting
- (16) SOCKET UNIT
According to the specification of the device, this unit converts the pin configuration.
- (17)PASS/FAIL LED
To indicate the status of the device.The result of programming is indicated in each socket in different color.
- (18)Cooling window 
Do not cover it. (Refer to Safety precaution.)
- (19)Cooling Fan 
Do not cover it. (Refer to Safety precaution.)
- (20)RS232C connector
- (21)Power switch
- (22)Power connector
- (23)USB connector
When USB is used, USB drive must be installed on the PC.Please refer to the installation guide of USB driver.

Socket unit

Socket unit

In order to support various devices in minimum types of socket adapters, socket units are designed. While it is supporting fast changing device specification, this architecture to convert this pin configuration on the base unit makes our solution more affordable.

Minato named the base and pin converter as socket unit.

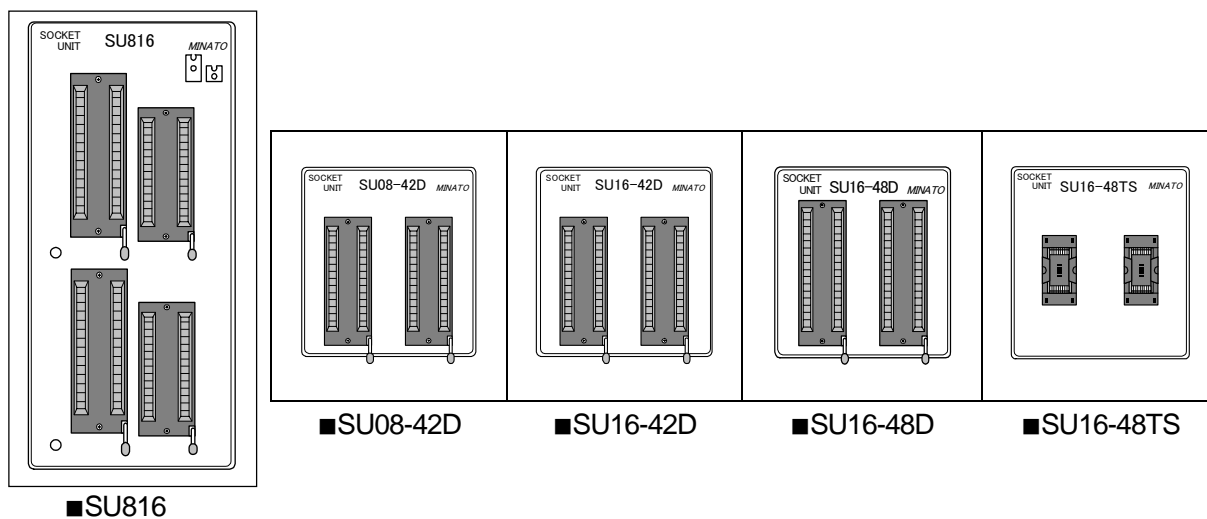

■SU816 (Device-Socket: 42-pin or 48-pin DIP)

This unit needs when 8bits,16bits device is used.

SU816 of unit is complexed SU08-42D and SU16-48D.

■SU08-42D (Device-Socket: 42-pin DIP)

This unit needs when 8bits device and micron is used.

■SU16-42D (Device-Socket: 42-pin DIP)

This unit needs when 16bits device(JEDEC type) is used.

■SU16-48D (Device-Socket: 48-pin DIP)

This unit needs when 16bits device(EIAJ type) is used.

■SU16-48TS (Device-Socket: 48-pin TSOP Type-I)

This unit needs when 16bits device(EIAJ type,48pin TSOP type-1) is used.

◎Numbering of the socket

[SU816]

It is number starting from upper to bottom socket 1 is indicate as #1 or NO.1 in this manual.

[SU08-42D,SU16-42D,SU16-48D,SU16-48TS]

It is number starting from left to right.Socket 1 is indicated as #1 or NO1 in this manual.

Changing socket unit

Type of socket unit depends on the targeted device. Socket unit must be changed to the other type if other type of device is targeted. The socket unit can be changed when the power is on.

When you copy a master data, please insert it on LED number 1 and 2.

In case of others, M1896 will operate if at least one unit is installed in any connector.

Coping a master data: (This chapter: Please refer to COPY)

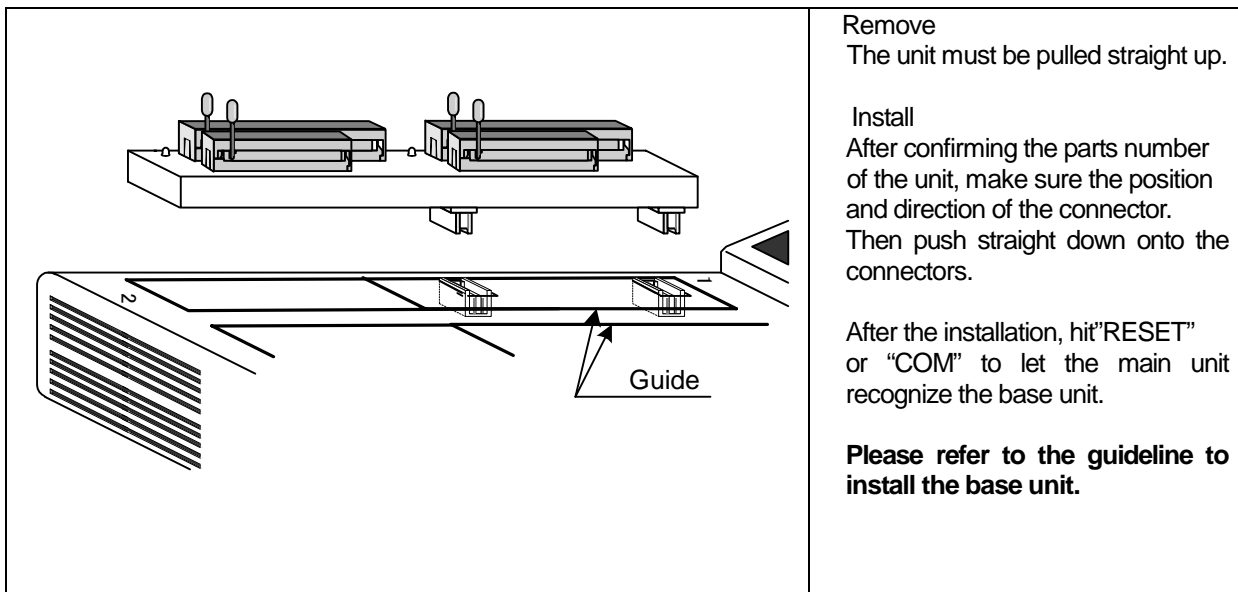

Remarks

The base unit must be inserted firmly. Otherwise, error or irregular operation is occurred.

Do not slant it and insert. Do not apply too much pressure on the base unit. That may damage the connector.

Minimum quantity of the base unit to run the unit is one. When multiple number of the base unit is used, make sure that the same type is used. When different types are inserted and hit start, COPY, BLANK does not run and M1896 displays Socket Unit Error.

The same type of base unit can be installed in any slot. Please refer to separate device code list for the appropriate socket unit for each device.

The function of the key differs whether a socket unit is installed or not.

©Status chart

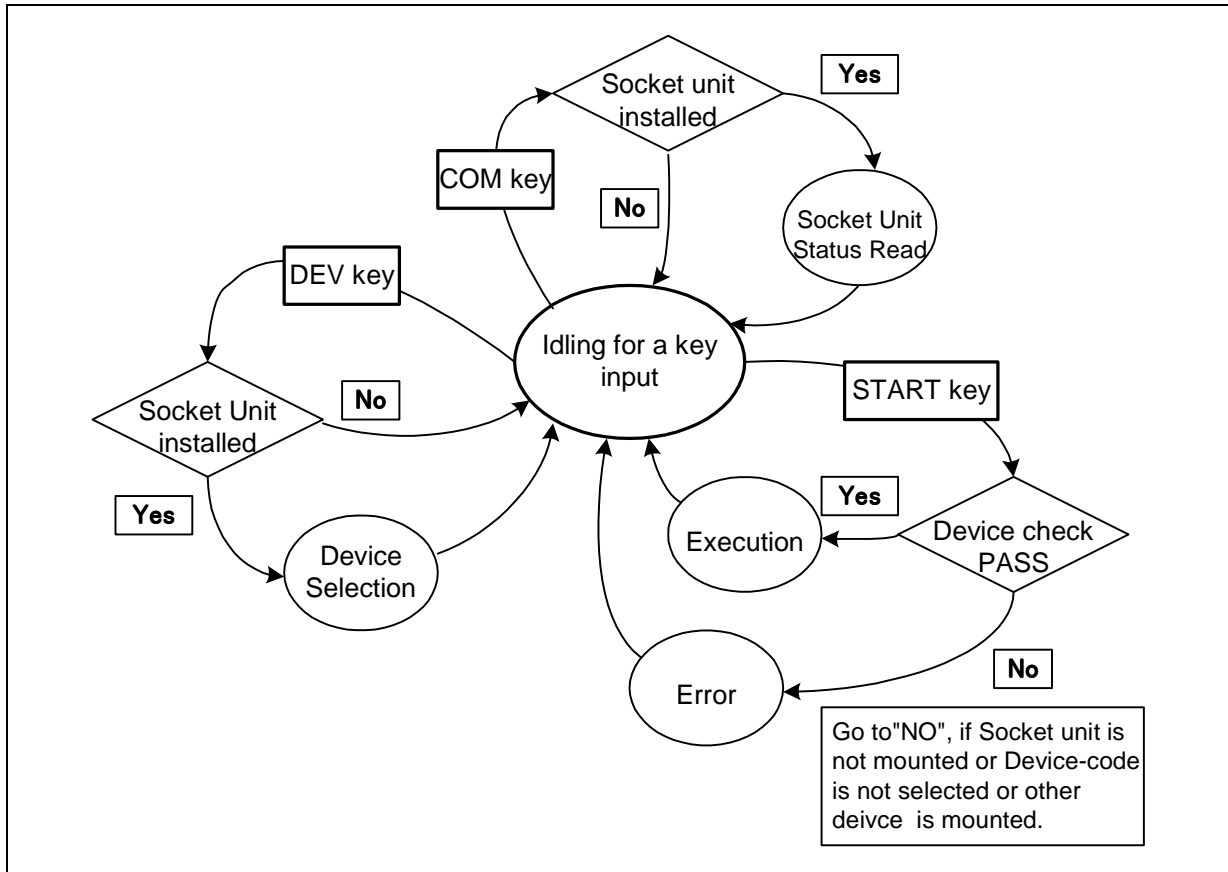

◎Combination of device package and socket unit

Dip and TSOP(48-pin Type-1) device can be inserted directly in socket unit. For other package, a set of conversion adapters and socket unit are required according to the specification of the device.

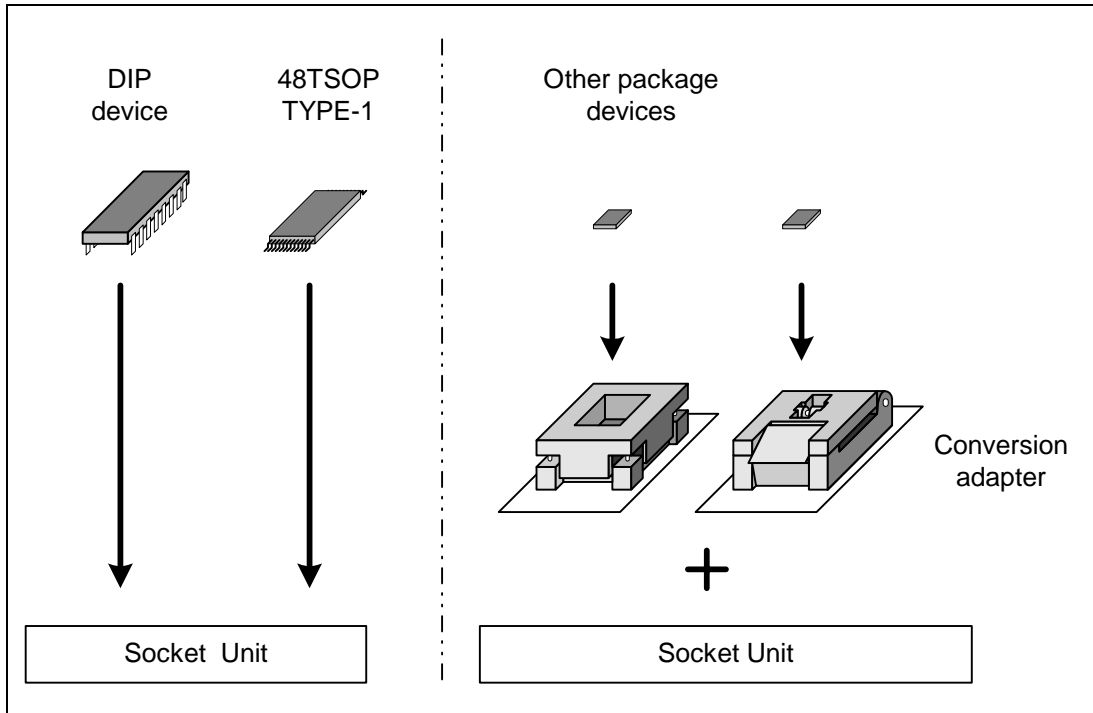

◎Corresponding table

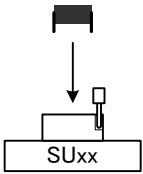
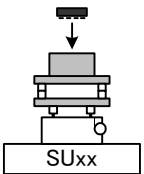
Device type	Package type	Using units	Setting image	
				
8bit	DIP	M1896 +SU08-42D +PROM M1896 +SU816 +PROM	○	—
	Others	“ + “ +Conversion adapter +PROM	—	○
16bit(JEDEC)	DIP	M1896 +SU16-42D +PROM	○	—
	Others	“ + “ +Conversion adapter +PROM	—	○
16bit(EIAJ)	DIP	M1896 +SU16-48D +PROM M1896 +SU816 +PROM	○	—
	48TSOP(I)	“ +SU16-48TS+PROM	○	—
	Others	“ +SU16-48D +Conversion adapter+PROM +PROM “ +SU816 +Conversion adapter +PROM	—	○

Inserting a device in a socket

This is to describe how to insert a device.

DIP device (SU816 Socket unit)

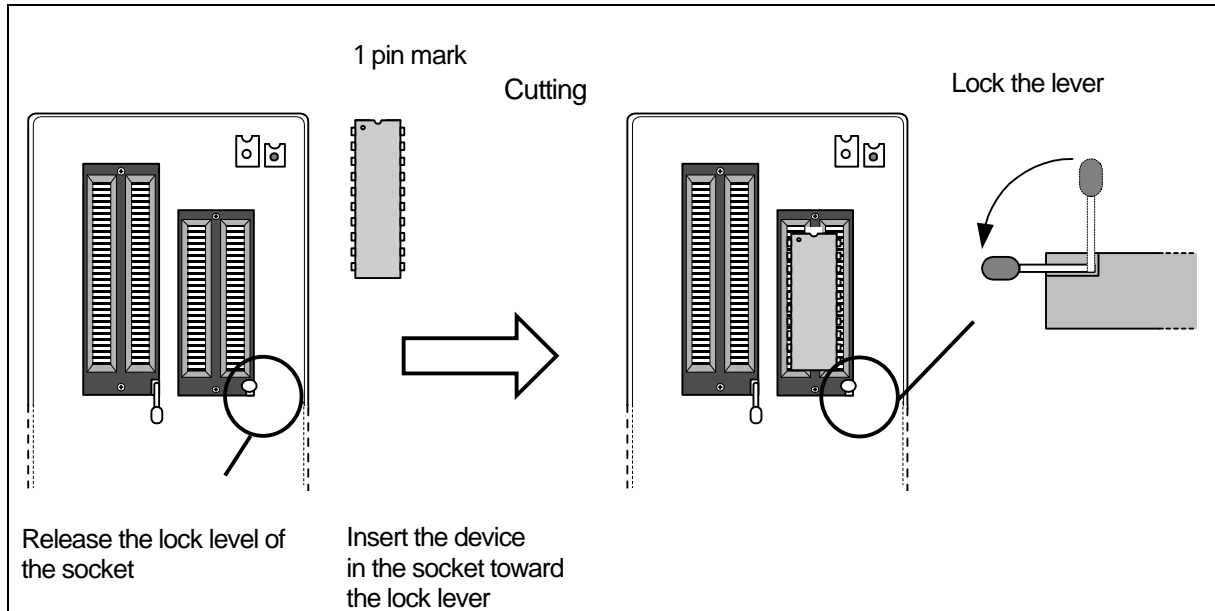

Remarks : Do not set the device while lever is locked. It may damage the socket.

Lock the lever firmly. Otherwise, error or irregular operation is occurred.

In this manual,"set a device" means not only inserting device in the socket,but lock the lever to fix the device on the socket.

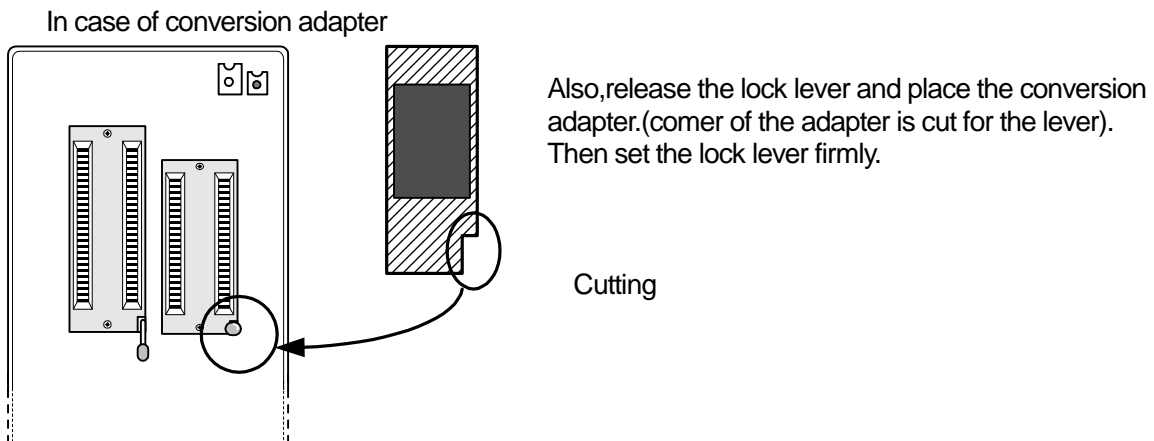

8bit ,16bit device is not used on SU-816 simultaneously.

SU-816 has different sockets, left side socket is proper for SU08-42D, Right side socket is proper for SU16-48D. LED is turned on proper socket when device is selected.

How to read display

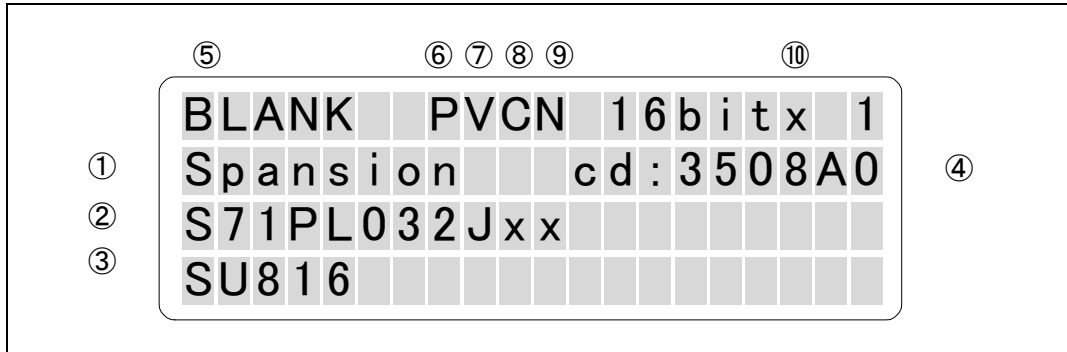

Device supplier

Device name

Type of socket unit

Device code

Basic function ("COPY", "ERASE", "BLANK", "PROG", "VERIFY", "CONT") is displayed.

~ Display of advance operation

" P " : When programming address is specified, "P" is indicated. (Advance operation : Refer to PAE)

" M " : When programming address is specified, "M" is indicated. (Advance operation : Refer to Multi PAE)

" S " : When set programming mode is used, "S" is indicated. (Advance operation : Refer to Set PRG MODE)

" V " : When the number of "VERIFY" is changed, "v" is indicated. (Advance operation : Refer to VERIFY PATTERN)

" C " : When VCC is changed, "C" READ is indicated (Advance operation : Refer to PROTECT MODE)

" N " : When sector protect is valid, " N ", " P ", " U " is indicated.

(Advance operation : Refer to PROTECT MODE)

Data length

Data length of the targeted device and the statue of "Set Programming" are indicated.

(Advance operation : Refer to SET PRG MODE)

Key operation on initial display

This is to explain key operation on initial display.

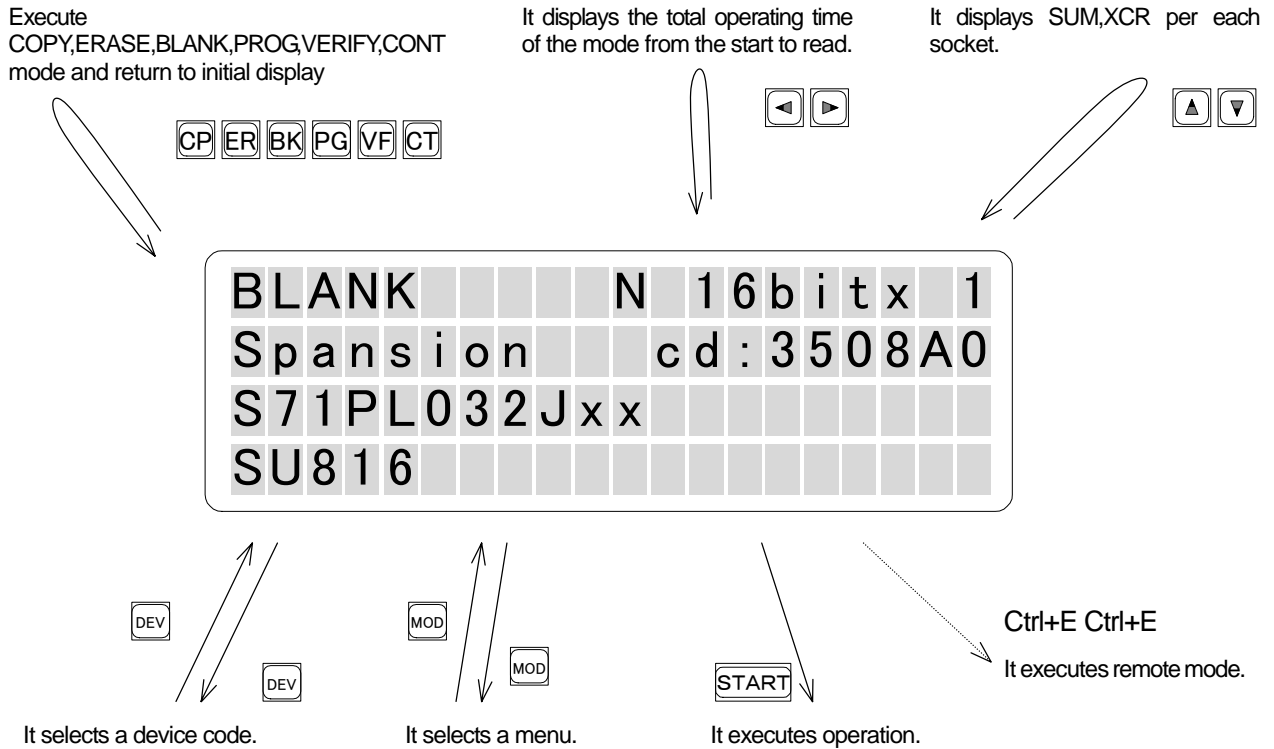

REMARKS : Arrow mark in this manual shows the flow of process of M1896.

U turns sign in this manual means that the menu return to the initial one after completing the selected process.

* Also , RESET key can be used to return to the initial display.: **RESET**

Warning : Do to press RESET key while ERASE,PROG, and CONT mode is in motion.It may damage the device.

BASIC OPERATION

To program a device	23
Set a device code	24
Auto Select	24
Setting a device by key operation	26
COPY (Copying device data)	28
ERASE (Erase data in a device)	30
BLANK (To check the erase statue of the device data)	32
PROG (To program device data)	34
VERIFY (To verify the deivce data and the buffer memory)	36
CONT (Continuous mode)	39
Remarks	42
Contact Check	42
ID check	43
Display of operating time	44
Display of SUM and XOR	44

To program a device

The following is the operation flow to program a device on M1896,

Set socket unit(s) on M1896 (For the operation : Please refer to socket Unit)

Select a device code (This chapter : Please refer to set device code)

Prepare programming data in the buffer memory of M1896.

Step1 : Copy a master ROM (This chapter : Please refer to COPY)

Step2 : Transfer data through data communication (Communication Feature : Please refer to data transfer)

Step3 : Edit data in buffer memory (Memory : Please refer to Buffer DUMP/EDIT)

Select Program/Continuous operating mode

(This chapter : Please refer to PROG,CONT)

Set a device in a socket

(For the operation : Please refer to Set a Device in a socket)

Press START key

Execute contact check on each pin of the device(automatic) (This chapter : Please refer to remarks)

Execute ID check of the device (automatic)

(This chapter : Please refer to remarks)

Program a device (automatic)

End (The result is displayed.)







Set a device code

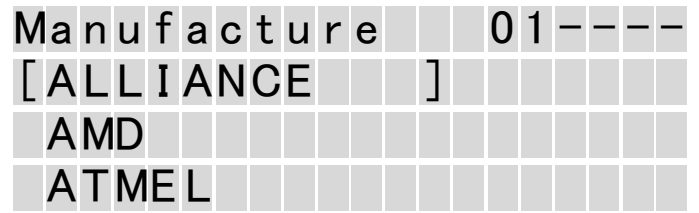
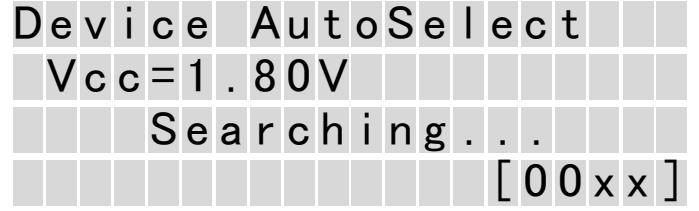

This is an operation to set a targeted device. In this manual, this operation is called, "Set a Device Code". By setting device code, particular information to program the targeted device is set on the programmer. Proprietary device code of MINATO programmer is targeted for each device. These codes are unique for Minato programmer and they are not applicable for other programmers or device suppliers. In M1896, there are two methods to set device: One is auto select and other is manual key operation.

◎Autoselect

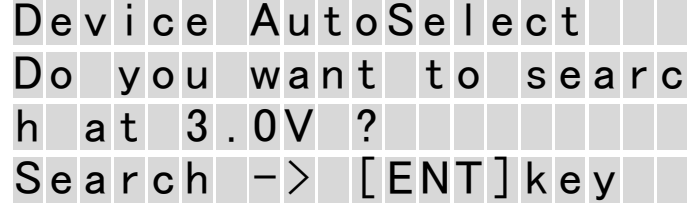
The auto select function of the programmer enables to read and search the device ID of each device. When the device code is found, the targeted device is displayed. When several devices are matched to the device ID which is selected by the programmer, all the applicable devices are displayed. Select the targeted device among them. When either SU816 or SU16-48D or SU16-48TS is installed, auto select function becomes available.

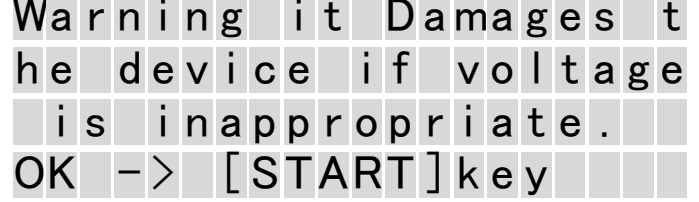
Example : Set Spansion S71PL032XX (3 v system 3 2 M)

<p> </p> <p>After setting a device on the socket#1, press DEV key. Then the display shows the message as identified on the right. Press START to execute auto select</p>	
<p>[Seaching Display] Device ID is search on Vcc 1.8V system.</p> <p>The search is accomplished the following sequence.</p>	
<p></p> <p>No match is found at VCC 1,8, Then it is seached at VCC3.0v. Press ENT key to continue.</p>	
<p></p> <p>A warning message is displayed.To continue, press START key.</p>	

<p> ENT</p> <p>Matched device is S71PL032JXX. Press ENT key.</p>	<pre> Device Select [S71PL032Jxx] ..more.. </pre>
<p> START</p> <p>Confirm the setting and press START key if it is OK.</p>	<pre> Select device Span sion cd:3508A0 S71PL032Jxx OK -> [START] key </pre>
<p>M1896 displays the initial display and end the operation.</p> <p>When the device code is changed, the default mode is turned to BLANK.</p>	<pre> BLANK N 16bitx 1 Span sion cd:3508A0 S71PL032Jxx SU816 </pre>

Remarks : The search of 1.8v is included in the search of 3v system and it is the same as 5v system.
If multiple devices are matched without matching the targeted device, move the cursor to "more" and press ENT key to continue the search.
When the targeted device is not searched by auto select, set the device by manual key operation.













Setting a device by key operation

The operator following the display message and select a device by the following sequence:

Supplier Size Part number of the device

Remarks : When a socket unit is not installed or wrong socket unit is installed, the targeted device is not displayed.

: " To select Spansion, 32M, S71PL032Jxx " (Socket unit : SU816)

<p>  >   Move the cursor to "Spansion" </p>	<pre> Manufacture 35----- SHARP SILICON7 [Spansion] </pre>
<p>  >     Move the cursor to "32M" </p>	<pre> Capacity 3508-- 1M 2M 4M 8M 16M [32M] </pre>
<p>  >   Move the cursor to "S71PL032Jxx" </p>	<pre> Device Select 3508A0 S29JL032Hxx1_48F S29JL032Hxx2_48F [S71PL032Jxx] </pre>
<p>  >  Confirm the setting and press START key if it is OK. </p>	<pre> Select device Spansion cd:3508A0 S71PL032Jxx OK -> [START] key </pre>

COPY — Copying device data —

Reading data in a device and store it in the buffer memory of M1896.

Is used to copy data of the master ROM.

<p>CP</p> <p>Set the device to copy in the socket #1.</p> <p>START : Execute "COPY"</p>	<table border="1"> <tr><td>COPY</td><td></td><td></td><td></td><td></td><td></td><td></td><td></td><td></td><td></td><td>N</td><td>1</td><td>6</td><td>b</td><td>i</td><td>t</td><td>x</td><td>1</td></tr> <tr><td>S</td><td>p</td><td>a</td><td>n</td><td>s</td><td>i</td><td>o</td><td>n</td><td></td><td></td><td>c</td><td>d</td><td>:</td><td>3</td><td>5</td><td>0</td><td>8</td><td>A</td><td>0</td></tr> <tr><td>S</td><td>7</td><td>1</td><td>P</td><td>L</td><td>0</td><td>3</td><td>2</td><td>J</td><td>x</td><td>x</td><td></td><td></td><td></td><td></td><td></td><td></td><td></td><td></td></tr> <tr><td>S</td><td>U</td><td>8</td><td>1</td><td>6</td><td></td><td></td><td></td><td></td><td></td><td></td><td></td><td></td><td></td><td></td><td></td><td></td><td></td><td></td></tr> </table>	COPY										N	1	6	b	i	t	x	1	S	p	a	n	s	i	o	n			c	d	:	3	5	0	8	A	0	S	7	1	P	L	0	3	2	J	x	x									S	U	8	1	6														
COPY										N	1	6	b	i	t	x	1																																																											
S	p	a	n	s	i	o	n			c	d	:	3	5	0	8	A	0																																																										
S	7	1	P	L	0	3	2	J	x	x																																																																		
S	U	8	1	6																																																																								

Remarks : When copy is completed, M1896 starts VERIFY.

To execute COPY once again, it is not necessary to press COPY. Press only START to execute COPY in such case.

Warning : Even if a device is set on the other socket than #1, the data cannot be copied. It is not necessary to set a device on #1 socket. The contact check and the result of this operation are based on the statuses of #1.

That of other sockets is ignored.

Check the sum of master ROM in advance.

Little endian method is applicable for M1896. (Memory : Please refer to little endian)

Targeted COPY socket is different when SET PRG mode is used.

(Advance mode : Please refer to " Set Prg mode")

Display result

When Passed

<p>LED</p> <p>#1 : Green light is lit</p> <p>#2-8 : Red light is lit</p> <p>BUZZER</p> <p>: Short beep</p>	<p>Display: Check sum and XOR are displayed</p> <table border="1"> <tr><td>COPY</td><td></td><td></td><td></td><td></td><td></td><td></td><td></td><td></td><td></td><td>N</td><td>1</td><td>6</td><td>b</td><td>i</td><td>t</td><td>x</td><td>1</td></tr> <tr><td>S</td><td>p</td><td>a</td><td>n</td><td>s</td><td>i</td><td>o</td><td>n</td><td></td><td></td><td>c</td><td>d</td><td>:</td><td>3</td><td>5</td><td>0</td><td>8</td><td>A</td><td>0</td></tr> <tr><td>S</td><td>7</td><td>1</td><td>P</td><td>L</td><td>0</td><td>3</td><td>2</td><td>J</td><td>x</td><td>x</td><td></td><td></td><td></td><td></td><td></td><td></td><td></td><td></td></tr> <tr><td>S</td><td>U</td><td>M</td><td>:</td><td>x</td><td>x</td><td>x</td><td>x</td><td>X</td><td>O</td><td>R</td><td>:</td><td>x</td><td>x</td><td></td><td></td><td></td><td></td><td></td></tr> </table>	COPY										N	1	6	b	i	t	x	1	S	p	a	n	s	i	o	n			c	d	:	3	5	0	8	A	0	S	7	1	P	L	0	3	2	J	x	x									S	U	M	:	x	x	x	x	X	O	R	:	x	x					
COPY										N	1	6	b	i	t	x	1																																																											
S	p	a	n	s	i	o	n			c	d	:	3	5	0	8	A	0																																																										
S	7	1	P	L	0	3	2	J	x	x																																																																		
S	U	M	:	x	x	x	x	X	O	R	:	x	x																																																															

When Failed

<p>LED</p> <p>#1-8 : Red light is lit</p> <p>BUZZER</p> <p>: Continuous short beep</p>	<p>Display: FAIL address, memory data and Device data are displayed</p> <table border="1"> <tr><td>COPY</td><td></td><td></td><td></td><td></td><td></td><td></td><td></td><td></td><td></td><td>N</td><td>1</td><td>6</td><td>b</td><td>i</td><td>t</td><td>x</td><td>1</td></tr> <tr><td>S</td><td>p</td><td>a</td><td>n</td><td>s</td><td>i</td><td>o</td><td>n</td><td></td><td></td><td>c</td><td>d</td><td>:</td><td>3</td><td>5</td><td>0</td><td>8</td><td>A</td><td>0</td></tr> <tr><td>S</td><td>7</td><td>1</td><td>P</td><td>L</td><td>0</td><td>3</td><td>2</td><td>J</td><td>x</td><td>x</td><td></td><td></td><td></td><td></td><td></td><td></td><td></td><td></td></tr> <tr><td>x</td><td>x</td><td>x</td><td>x</td><td>x</td><td>x</td><td>x</td><td>x</td><td>x</td><td>x</td><td>x</td><td>x</td><td>x</td><td>x</td><td>x</td><td>x</td><td>x</td><td>x</td><td>x</td></tr> </table>	COPY										N	1	6	b	i	t	x	1	S	p	a	n	s	i	o	n			c	d	:	3	5	0	8	A	0	S	7	1	P	L	0	3	2	J	x	x									x	x	x	x	x	x	x	x	x	x	x	x	x	x	x	x	x	x	x
COPY										N	1	6	b	i	t	x	1																																																											
S	p	a	n	s	i	o	n			c	d	:	3	5	0	8	A	0																																																										
S	7	1	P	L	0	3	2	J	x	x																																																																		
x	x	x	x	x	x	x	x	x	x	x	x	x	x	x	x	x	x	x																																																										

Right and Left key to display operating time

(This chapter : Please refer to remarks)

Flow chart of "COPY" mode operation

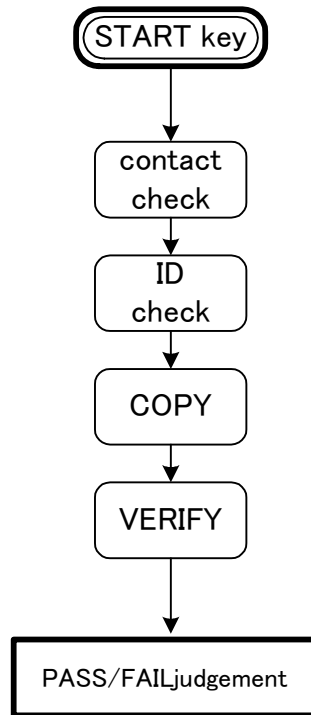

ERASE — Erase data in a device —

This is to erase memory data in a device

<div style="border: 1px solid black; padding: 2px; display: inline-block; margin-bottom: 10px;">ER</div> <div style="border: 1px solid black; padding: 2px; display: inline-block;">START</div> : Execute "ERASE"	<table border="1" style="border-collapse: collapse; width: 100%; height: 100%;"> <tr><td>ERASE</td><td></td><td></td><td></td><td></td><td></td><td></td><td></td><td></td><td></td><td>N</td><td>1</td><td>6</td><td>b</td><td>i</td><td>t</td><td>x</td><td>1</td></tr> <tr><td>S</td><td>p</td><td>a</td><td>n</td><td>s</td><td>i</td><td>o</td><td>n</td><td></td><td></td><td>c</td><td>d</td><td>:</td><td>3</td><td>5</td><td>0</td><td>8</td><td>A</td><td>0</td></tr> <tr><td>S</td><td>7</td><td>1</td><td>P</td><td>L</td><td>0</td><td>3</td><td>2</td><td>J</td><td>x</td><td>x</td><td></td><td></td><td></td><td></td><td></td><td></td><td></td><td></td></tr> <tr><td>S</td><td>U</td><td>8</td><td>1</td><td>6</td><td></td><td></td><td></td><td></td><td></td><td></td><td></td><td></td><td></td><td></td><td></td><td></td><td></td><td></td></tr> </table>	ERASE										N	1	6	b	i	t	x	1	S	p	a	n	s	i	o	n			c	d	:	3	5	0	8	A	0	S	7	1	P	L	0	3	2	J	x	x									S	U	8	1	6														
ERASE										N	1	6	b	i	t	x	1																																																											
S	p	a	n	s	i	o	n			c	d	:	3	5	0	8	A	0																																																										
S	7	1	P	L	0	3	2	J	x	x																																																																		
S	U	8	1	6																																																																								

If there is any socket without device insertion among 8 sockets, "Empty Socket" is displayed in the display. Then empty socket is indicated with red LED and stops the operation. To continue, please START key.

Remarks : When ERASE is completed, M1896 starts BLANK.

Warning : Erase mode is applicable only for EE-PROM and FLASH which can be erased electrically.

In case of E-PROM, this key is not applicable.

When erase is executed, all data in the device is changed to all "FFFFh"

(In case of 8-bit device, it is "FFh" instead.)

Display result

When Passed

<p>LED</p> <p>PASS Socket : Green light is lit</p> <p>Empty Socket : Red light is lit</p> <p>BUZZER</p> <p>: Short beep</p>	<p>Display: End address is displayed</p> <table border="1" style="border-collapse: collapse; width: 100%; height: 100%;"> <tr><td>ERASE</td><td></td><td></td><td></td><td></td><td></td><td></td><td></td><td></td><td></td><td>N</td><td>1</td><td>6</td><td>b</td><td>i</td><td>t</td><td>x</td><td>1</td></tr> <tr><td>S</td><td>p</td><td>a</td><td>n</td><td>s</td><td>i</td><td>o</td><td>n</td><td></td><td></td><td>c</td><td>d</td><td>:</td><td>3</td><td>5</td><td>0</td><td>8</td><td>A</td><td>0</td></tr> <tr><td>S</td><td>7</td><td>1</td><td>P</td><td>L</td><td>0</td><td>3</td><td>2</td><td>J</td><td>x</td><td>x</td><td></td><td></td><td></td><td></td><td></td><td></td><td></td><td></td></tr> <tr><td>x</td><td>x</td><td>x</td><td>x</td><td>x</td><td>x</td><td>x</td><td>x</td><td></td><td></td><td></td><td></td><td></td><td></td><td></td><td></td><td></td><td></td><td></td></tr> </table>	ERASE										N	1	6	b	i	t	x	1	S	p	a	n	s	i	o	n			c	d	:	3	5	0	8	A	0	S	7	1	P	L	0	3	2	J	x	x									x	x	x	x	x	x	x	x											
ERASE										N	1	6	b	i	t	x	1																																																											
S	p	a	n	s	i	o	n			c	d	:	3	5	0	8	A	0																																																										
S	7	1	P	L	0	3	2	J	x	x																																																																		
x	x	x	x	x	x	x	x																																																																					

When Failed

<p>LED</p> <p>PASS Socket : Green light is lit</p> <p>Fail Socket : Red light is lit</p> <p>Empty Socket : Red light is lit</p> <p>BUZZER</p> <p>: Continuous short beep</p>	<p>Display: FAIL address and memory data are displayed</p> <table border="1" style="border-collapse: collapse; width: 100%; height: 100%;"> <tr><td>ERASE</td><td></td><td></td><td></td><td></td><td></td><td></td><td></td><td></td><td></td><td>N</td><td>1</td><td>6</td><td>b</td><td>i</td><td>t</td><td>x</td><td>1</td></tr> <tr><td>S</td><td>p</td><td>a</td><td>n</td><td>s</td><td>i</td><td>o</td><td>n</td><td></td><td></td><td>c</td><td>d</td><td>:</td><td>3</td><td>5</td><td>0</td><td>8</td><td>A</td><td>0</td></tr> <tr><td>S</td><td>7</td><td>1</td><td>P</td><td>L</td><td>0</td><td>3</td><td>2</td><td>J</td><td>x</td><td>x</td><td></td><td></td><td></td><td></td><td></td><td></td><td></td><td></td></tr> <tr><td>x</td><td>x</td><td>x</td><td>x</td><td>x</td><td>x</td><td>x</td><td>x</td><td></td><td></td><td>x</td><td>x</td><td>x</td><td></td><td></td><td></td><td></td><td></td><td></td></tr> </table>	ERASE										N	1	6	b	i	t	x	1	S	p	a	n	s	i	o	n			c	d	:	3	5	0	8	A	0	S	7	1	P	L	0	3	2	J	x	x									x	x	x	x	x	x	x	x			x	x	x						
ERASE										N	1	6	b	i	t	x	1																																																											
S	p	a	n	s	i	o	n			c	d	:	3	5	0	8	A	0																																																										
S	7	1	P	L	0	3	2	J	x	x																																																																		
x	x	x	x	x	x	x	x			x	x	x																																																																

Right and left to display operating time

(This chapter : Please refer to remarks)

Flow chart of "ERASE" mode operation

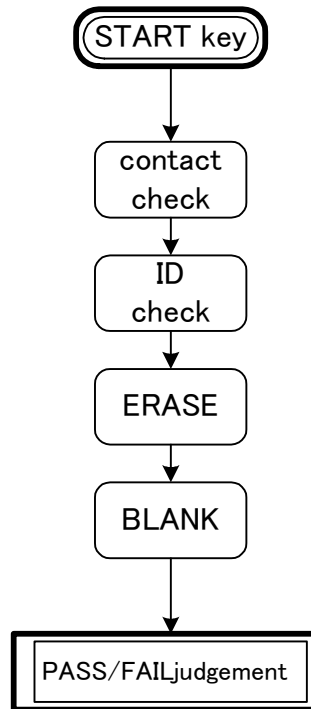

BLANK — To check the erase statues of the device data —

This is to check if the memory data of the device is BLANK.

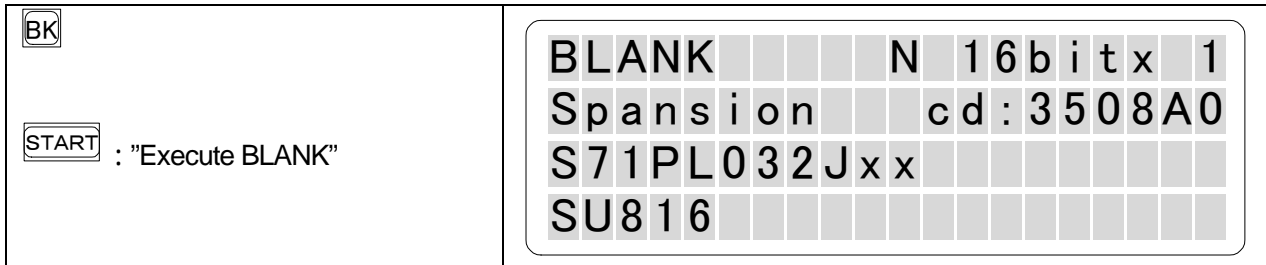

If there is any socket without device insertion among 16sockets,"Empty Socket" is displayed in the display. Then empty socket is indicated with red LED and stops the operation. To continue,please START KEY.

Remarks : To execute BLANK once again, it is not necessary to press BLANK. Press only START to execute BLANK in such case.

BLANK DATA:

8bit device : " FFh "

16bit device : " FFFFh "

Display result

When Passed

<p>LED PASS Socket : Green light is lit Empty Socket : Red light is lit BUZZER : Short beep</p>	<p>Display: End address is displayed</p> <table border="1" style="border-collapse: collapse; width: 100%; height: 100%;"> <tr><td>BLANK</td><td></td><td></td><td></td><td></td><td></td><td>N</td><td>1</td><td>6</td><td>b</td><td>i</td><td>t</td><td>x</td><td>1</td></tr> <tr><td>S</td><td>p</td><td>a</td><td>n</td><td>s</td><td>i</td><td>o</td><td>n</td><td></td><td></td><td></td><td></td><td>c</td><td>d</td><td>:</td><td>3</td><td>5</td><td>0</td><td>8</td><td>A</td><td>0</td></tr> <tr><td>S</td><td>7</td><td>1</td><td>P</td><td>L</td><td>0</td><td>3</td><td>2</td><td>J</td><td>x</td><td>x</td><td></td><td></td><td></td><td></td><td></td><td></td><td></td><td></td><td></td><td></td></tr> <tr><td>x</td><td>x</td><td>x</td><td>x</td><td>x</td><td>x</td><td>x</td><td>x</td><td></td><td></td><td></td><td></td><td></td><td></td><td></td><td></td><td></td><td></td><td></td><td></td><td></td></tr> </table>	BLANK						N	1	6	b	i	t	x	1	S	p	a	n	s	i	o	n					c	d	:	3	5	0	8	A	0	S	7	1	P	L	0	3	2	J	x	x											x	x	x	x	x	x	x	x													
BLANK						N	1	6	b	i	t	x	1																																																																	
S	p	a	n	s	i	o	n					c	d	:	3	5	0	8	A	0																																																										
S	7	1	P	L	0	3	2	J	x	x																																																																				
x	x	x	x	x	x	x	x																																																																							

When Failed

<p>LED PASS Socket : Green light is lit Fail Socket : Red light is lit Empty Socket : Red light is lit BUZZER : Continous short beep</p>	<p>Display:FAIL address and memory data are displayed</p> <table border="1" style="border-collapse: collapse; width: 100%; height: 100%;"> <tr><td>BLANK</td><td></td><td></td><td></td><td></td><td></td><td>N</td><td>1</td><td>6</td><td>b</td><td>i</td><td>t</td><td>x</td><td>1</td></tr> <tr><td>S</td><td>p</td><td>a</td><td>n</td><td>s</td><td>i</td><td>o</td><td>n</td><td></td><td></td><td></td><td></td><td>c</td><td>d</td><td>:</td><td>3</td><td>5</td><td>0</td><td>8</td><td>A</td><td>0</td></tr> <tr><td>S</td><td>7</td><td>1</td><td>P</td><td>L</td><td>0</td><td>3</td><td>2</td><td>J</td><td>x</td><td>x</td><td></td><td></td><td></td><td></td><td></td><td></td><td></td><td></td><td></td><td></td></tr> <tr><td>x</td><td>x</td><td>x</td><td>x</td><td>x</td><td>x</td><td>x</td><td>x</td><td></td><td></td><td></td><td></td><td></td><td></td><td></td><td></td><td></td><td></td><td></td><td></td><td></td></tr> </table>	BLANK						N	1	6	b	i	t	x	1	S	p	a	n	s	i	o	n					c	d	:	3	5	0	8	A	0	S	7	1	P	L	0	3	2	J	x	x											x	x	x	x	x	x	x	x													
BLANK						N	1	6	b	i	t	x	1																																																																	
S	p	a	n	s	i	o	n					c	d	:	3	5	0	8	A	0																																																										
S	7	1	P	L	0	3	2	J	x	x																																																																				
x	x	x	x	x	x	x	x																																																																							

Right and Left key to display operating time

(This chapter : Please refer to remarks)

Flow chart of "BLANK " mode operation

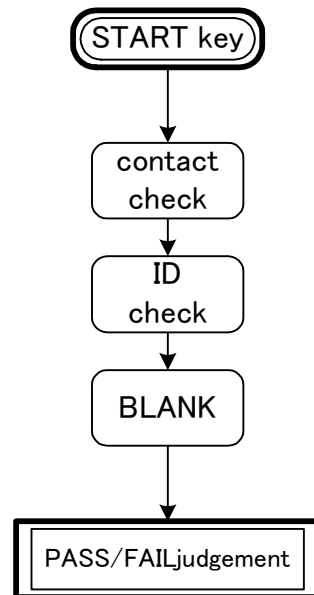

Flow chart of "PROG" mode operation

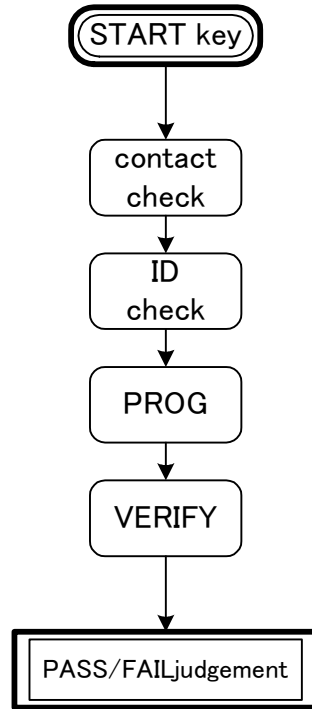

VERIFY — To verify the device data and the buffer memory —

This is to compare and the verify the programmed data in the device and the buffer memory of M1896. Usually several patterns of checking are carried out with different conditions such as voltage.

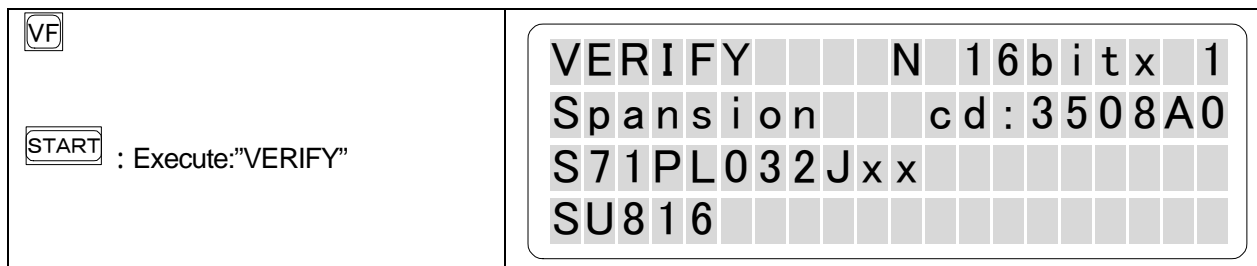

If there is any socket without device insertion among 8sockets, " Empty Socket" is displayed in the display. Then empty socket is indicated with red LED and stops the operation.To continue,please START key.

Remarks : To execute VERIFY once again, it is not necessary to press VERIFY.Press only START to execute VERIFY in such case.

VERIFY Pattern and Check condition

Pattern	Vcc voltage	Check condition	Remarks
VERIFY1	VccL	PULL-UP (to VCC)	not USE
VERIFY2	VccL	PULL-DOWN (GND)	
VERIFY3	VccH	PULL-UP (to VCC)	
VERIFY4	VccH	PULL-DOWN (GND)	not USE

Remarks : VccL(VCC Voltage-10%)
VccH(VCC Voltage+10%)

Type of Device and Check

Type of device	Check pattern of VERIFY
E-PROM	VERIFY2 VERIF3
EE-PROM	VERIFY2 VERIF3
FLASH	VERIFY2 VERIF3

Remarks : Usually 2 or 3sets of patterns are carried out in two cycles.

In M1896, VERIFY 1 and 4 are not applicable.For the compatibility of our other programmer, VERIFY 2 and 3 are used.

Display result

When passed

<p>LED PASS Socket : Green light is lit Empty Socket : Red light is lit BUZZER : Short beep</p>	<p>Display: Check sum and XOR are displayed</p> <table border="1" data-bbox="798 459 1260 604"> <tr><td>V</td><td>E</td><td>R</td><td>I</td><td>F</td><td>Y</td><td></td><td></td><td></td><td>N</td><td>1</td><td>6</td><td>b</td><td>i</td><td>t</td><td>x</td><td>1</td></tr> <tr><td>S</td><td>p</td><td>a</td><td>n</td><td>s</td><td>i</td><td>o</td><td>n</td><td></td><td>c</td><td>d</td><td>:</td><td>3</td><td>5</td><td>0</td><td>8</td><td>A</td><td>0</td></tr> <tr><td>S</td><td>7</td><td>1</td><td>P</td><td>L</td><td>0</td><td>3</td><td>2</td><td>J</td><td>x</td><td>x</td><td></td><td></td><td></td><td></td><td></td><td></td></tr> <tr><td>S</td><td>U</td><td>M</td><td>:</td><td>x</td><td>x</td><td>x</td><td>x</td><td>X</td><td>O</td><td>R</td><td>:</td><td>x</td><td>x</td><td></td><td></td><td></td></tr> </table>	V	E	R	I	F	Y				N	1	6	b	i	t	x	1	S	p	a	n	s	i	o	n		c	d	:	3	5	0	8	A	0	S	7	1	P	L	0	3	2	J	x	x							S	U	M	:	x	x	x	x	X	O	R	:	x	x			
V	E	R	I	F	Y				N	1	6	b	i	t	x	1																																																						
S	p	a	n	s	i	o	n		c	d	:	3	5	0	8	A	0																																																					
S	7	1	P	L	0	3	2	J	x	x																																																												
S	U	M	:	x	x	x	x	X	O	R	:	x	x																																																									

When Failed

<p>LED PASS Socket : Green light is lit Fail Socket : Red light is lit Empty Socket : Red light is lit BUZZER : Continuous short beep</p>	<p>Display: FAIL address and memory data are displayed</p> <table border="1" data-bbox="798 757 1260 902"> <tr><td>V</td><td>E</td><td>R</td><td>I</td><td>F</td><td>Y</td><td></td><td></td><td></td><td>N</td><td>1</td><td>6</td><td>b</td><td>i</td><td>t</td><td>x</td><td>1</td></tr> <tr><td>S</td><td>p</td><td>a</td><td>n</td><td>s</td><td>i</td><td>o</td><td>n</td><td></td><td>c</td><td>d</td><td>:</td><td>3</td><td>5</td><td>0</td><td>8</td><td>A</td><td>0</td></tr> <tr><td>S</td><td>7</td><td>1</td><td>P</td><td>L</td><td>0</td><td>3</td><td>2</td><td>J</td><td>x</td><td>x</td><td></td><td></td><td></td><td></td><td></td><td></td></tr> <tr><td>x</td><td>x</td><td>x</td><td>x</td><td>x</td><td>x</td><td>x</td><td>x</td><td>x</td><td>x</td><td>x</td><td>x</td><td></td><td></td><td></td><td></td><td></td></tr> </table>	V	E	R	I	F	Y				N	1	6	b	i	t	x	1	S	p	a	n	s	i	o	n		c	d	:	3	5	0	8	A	0	S	7	1	P	L	0	3	2	J	x	x							x	x	x	x	x	x	x	x	x	x	x	x					
V	E	R	I	F	Y				N	1	6	b	i	t	x	1																																																						
S	p	a	n	s	i	o	n		c	d	:	3	5	0	8	A	0																																																					
S	7	1	P	L	0	3	2	J	x	x																																																												
x	x	x	x	x	x	x	x	x	x	x	x																																																											

Right and Left key to display operating time

(This chapter : Please refer to remarks)

Flow chart of "VERIFY" mode operation

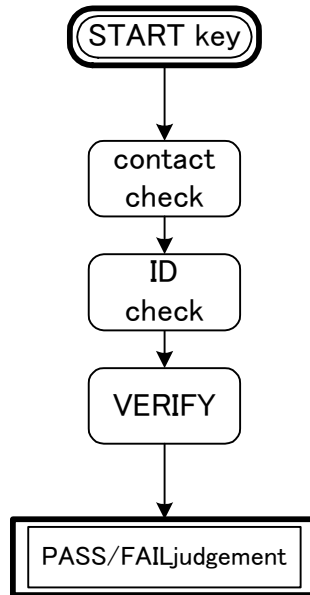

Flow chart of "CONT" mode operation (E-PROM type)

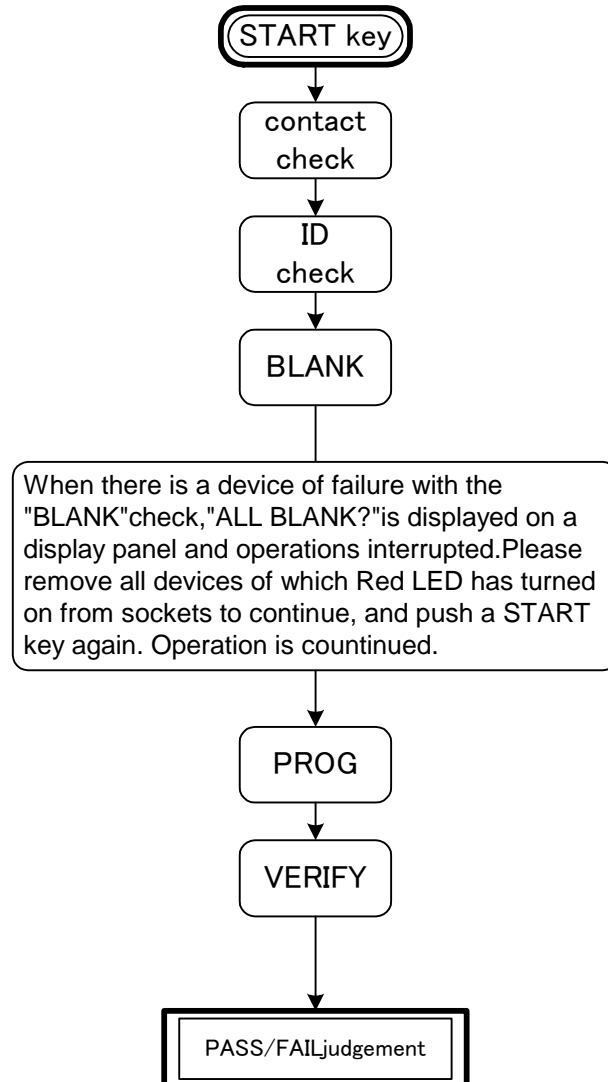

Flow chart of "CONT" mode operation (FLASH AND EE-PROM type)

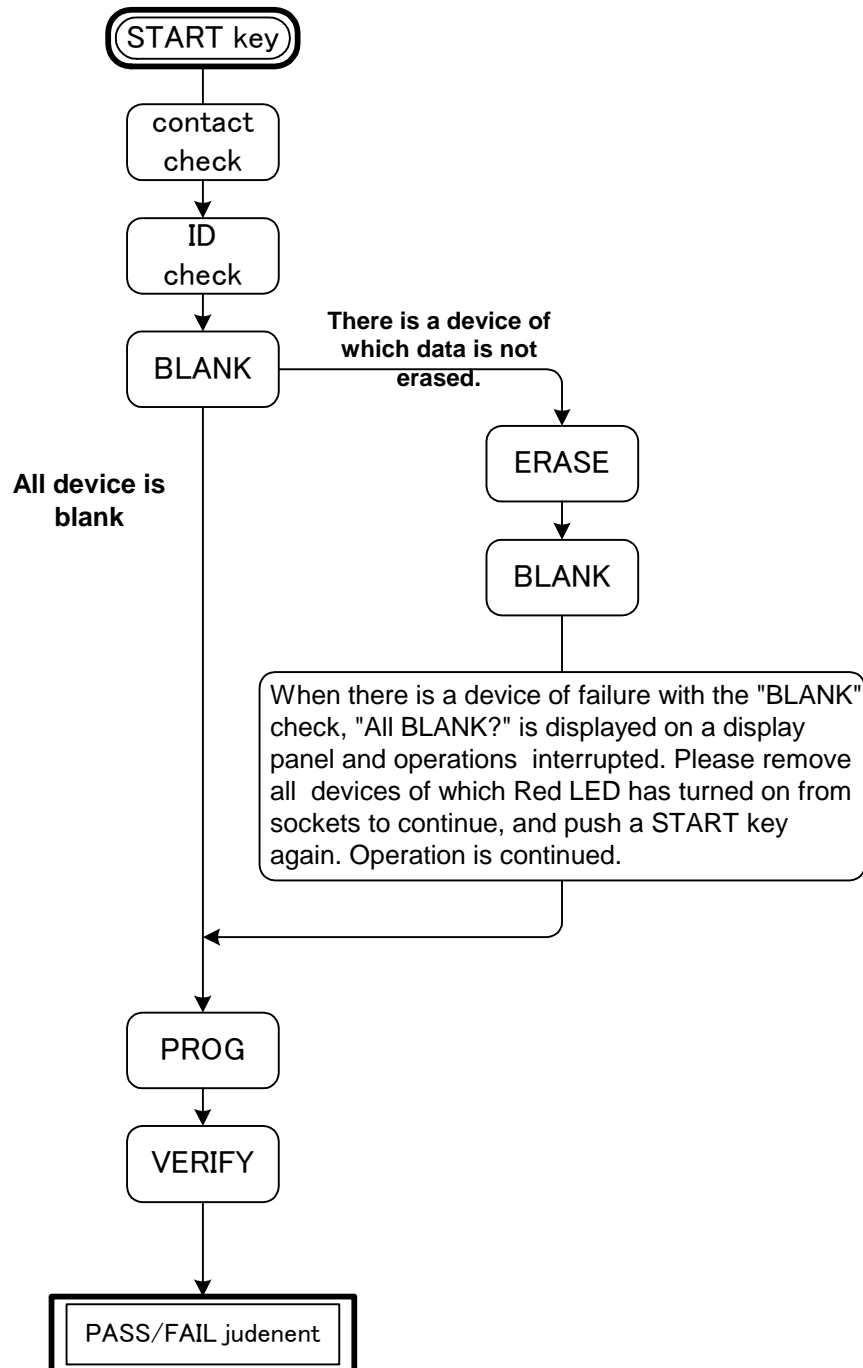

Remark

Contact check

Before executing "COPY,ERASE ,BLANK,PROG,VERIFY,CONT", M1896 electrically checks the device if it is correctly inserted in the socket. We called it Device Contact Check.

The device may be damaged if the direction of the device is incorrect which cause over current or voltage exceeding the capacity of the device.

If the pin is not contacted and programming is executed,wrong data could be programmed in the device.

The contact check of M1896 avoids such an accident.

Socket status and LED

No device is inserted	Red LED is lit on the corresponding socket without a device.
Check fail	Red LED is lit on the corresponding socket for check fail.
Check pass	No LED is lit on the corresponding socket for check pass.

Socket status and the process of M1896

All socket check pass	Execute the process
Socket with a device	Continue the contact check
Socket check fail	Continue the contact check

Remarks : When only socket to1 to 7 is used, pressing START key to skips the contact check

The status of "1 socket is applied for COPY. When the status of #1 socket is PASS in COPY mode, all sockets are regarded as PASS and continue the operation. The status of only the socket #1 is applied for the result of the completion of the operation.

Warning : When check fail device is observed, do not press START key. It damage the device.

Operating mode and applicable socket for the check

Operating mode	Applicable sockets
COPY	#1
ERASE	#1 ~ #8
BLANK	#1 ~ #8
PROG	#1 ~ #8
VERIFY	#1 ~ #8
CONT	#1 ~ #8

Remark

When contact error check is occurred, please check the following points.

- Device code
- The part number of socket adapter
- Lock lever of the socket
- Direction of the adapters
- Direction of the device

When all of above is not applicable, please check the following.

- Release the lever of the DIP socket and lock it once again.
- Remove the device and set in the socket once again.

If error still occurs presses RESET key and stop the operation.
Please note the phenomena and consult with MINATO authorized distributor.

ID Check

In 1896, device ID check is executed to avoid the mixture of different devices on the programmer.
ID check is executed along with contact check at COPY and PROG, etc operation.
When different devices are set on the programmer during ID check operation,
M1896 displays "ID Check Error" and change the color of the LED from green to red and ends the operation.

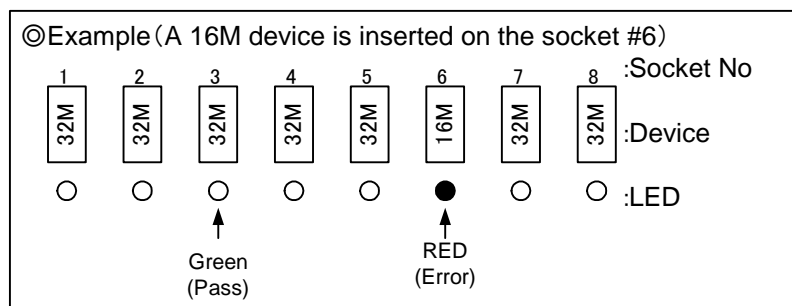
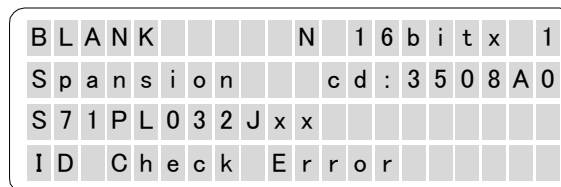

The devices code of M1896 share different devices(example S71PL032Jxx code:3508A0).
This code supports DL322-324 series devices. With this code M1896 works normally as far as the device with the same ID is used. When a device with different ID code is mixed,it is recognized as a mixture of different devices and ends the operation.

Remark

At this stage, M1896 recognizes the device ID of the socket #1(when no device is set on the socket "#1,any minimal # of the socket) as the master device.The other devices are recognized as different devices that are mixed by accident.

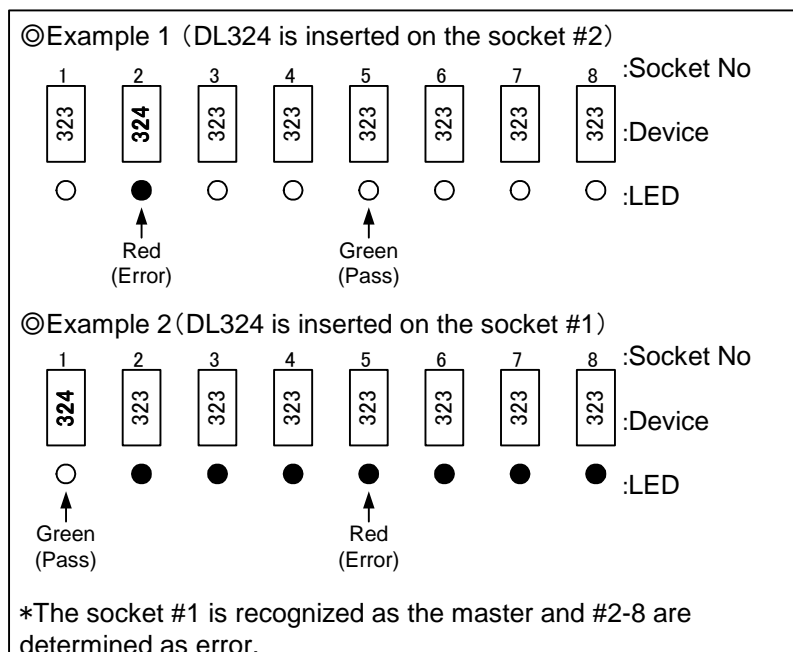

Remark::Mixture of devices with the same ID and different Vcc can not be recognized.

Display of operating time

When each operation such as COPY,BLANK,etc is completed,by pressing Left and Right keys to display the total time of the operation from start to the end.The operating time is renewed after each operation. The time is cleared and the message is changed to "-“when the device is changed or other operation key(Such as COPY,BLANK,etc) is pressed.

Display of SUM and XOR

When each operation (such as COPY,BLANK,etc) is completed, by pressing up/down arrow key let the display shows Check SUM and XOR.By keep pressing up/down key, the socket number scrolls.Hit the key several times until the targeted socket is displayed. When "Set Prg mode" is used,different time may be displayed due to the difference of the data in each socket. When it is not used,the same data is displayed.

ADVANCE OPERATION MODE

Advance operation mode	46
Using menu	46
List of menu	47
PAE (Specify operating address of the device)	48
Single PAE	49
Multi PAE	51
Read VCC (Changing device read volatage)	55
Verify Pattern(Changing the number of the verify)	56
ID Check(Setting of ID check)	57
Protect mode(Setting of device data protect mode)	58
Protect setting(To change protect setting for protected data)	61
Repeat mode(Setting of repeat mode)	62
Set Prg mode (Programming different data on multiple device)	63
Monitor mode (Checking of NAND device setting)	67

Advance operation mode

The most of function for basic programming are covered in the former chapter. Sometimes you may need to use advance function such as memory data edit to change the operating condition of the device and communication setting. This is to explain these advance operations and it's applications.

Using menu

All the function and it's setting of M1896 is summarized in the function table called "Main Menu".

Recalling Main Menu

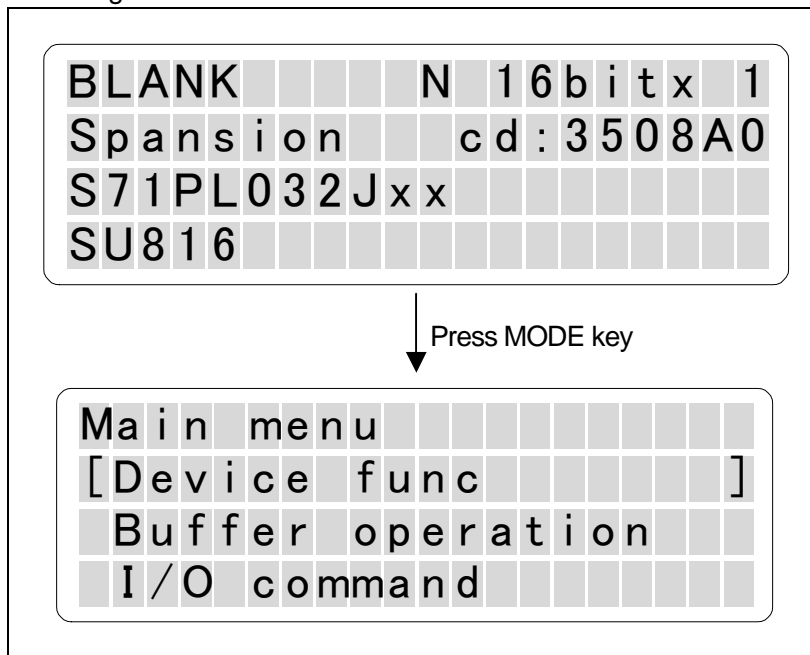

Items and out outlines

Title	Out lines
" Device Func "	Summarizes the operating environment of a device
" Buffer Operation "	Summarizes the function of memory operation
" I/O Command "	Summarizes the function data transfer
" System Config "	Summarizes the function of system environment
" Remote mode "	Summarizes the function of remote mode of the main unit
" Socket Unit "	Summarizes the expression socket unit is assembled

Key operation of Menu Display

Key	Process
UP/Down key	Move cursor
ENT key	Select the pointed area by the cursor and go to the next step
DEV Key	Go back to the former display for a selection
MODE key	Go to initial display

©List of menu

List 1	List 2	Functions	PAGE
Device func	Set Prg mode	Program different data in multiple devices	63
	PAE mode	Specify operating address of a device	48
	Read VCC	Change device read voltage	55
	Verify pattern	Change the number of verify	56
	ID Check	Set the mode of ID check	57
	Protect mode	Set device data protection	58
	Repeat mode	Set repeat operation	62
	Monitor mode	Confirmation of setting NAND device	67
Buffer operation	Buffer init	Intialize buffer memory data	70
	Buffer DUMP/EDIT	Dump and Edit buffer memory data	71
	Byte swap	Execute byte swap (per byte)	72
	Word swap	Execute data swap(per data)	73
	Check sum	Caluculate the sum of the buffer memory	74
	Protect setting	Change the protect setting of device data	61
	CRC16/32 calc	Calucuration of CRC16/32	75
I/O Command	Data SR In	Data transfer (Input :SERIAL I/F)	87
	Data SR Out	Data transfer(Output :SERIAL I/F)	88
	Protect SR In	Data transfer(Input: Protect data :SERIAL I/F)	89
	Protect SR Out	Data transfer(Output: Protect data :SERIAL I/F)	90
System config	RS config	Setting of RS232C	85
	Data format	Setting of data a format	86
	Devchk/BZ/LED	Setting of device check, buzzer, LED	77
	Version display	Checking system version,memory size	78
	System update	Upgrade system version	79
	Self check mode	Setting of self check	81
Remote mode	Remote	Execute remote mode	95
	Remote config	Setting of configuration of remote mode	93
	IF select	Select an interface	92
Socket Unit	Socket Unit	Display of socket unit	82

PAE — Specify operating address of the device —

In order to quicken programming device, M1896 has a function to enable to program only needed part. This function is called PAE. (Single PAE, Multi PAE)

New feature –Multi PAE detects data by sector blocks and enable to program only blocks where data should be in.

(During mode setting, data is automatically scanned. Targeted blocks to be programmed are automatically set after the scanning.) It shortens the programming time by skipping blocks accordingly.

[Explanation of the feature]

Standard programming - All area of a device is targeted.

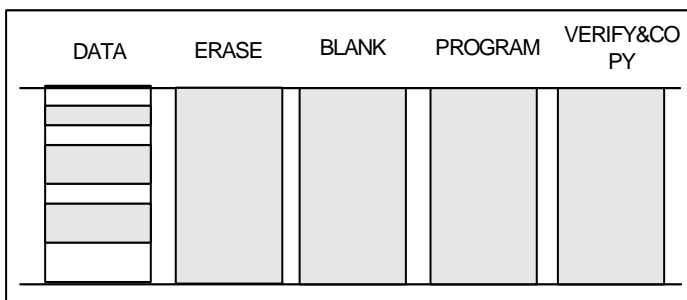

Erase, Blank, Program, Verify, Copy are targeted for all address of the device.

Single PAE - Only single designated address area is targeted.

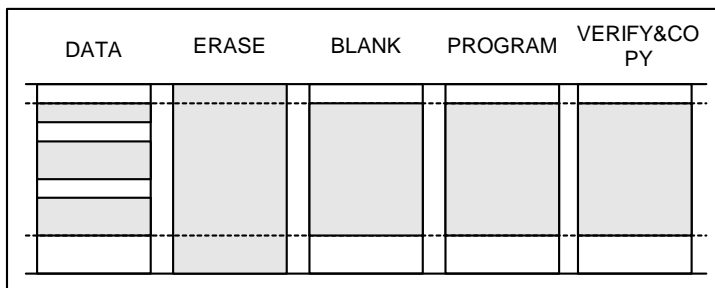

Blank, Program, Verify, Copy are targeted to designated PAE area.
Erase is targeted to all address area.

Multi PAE- Targeted to the blocks where data should be in.

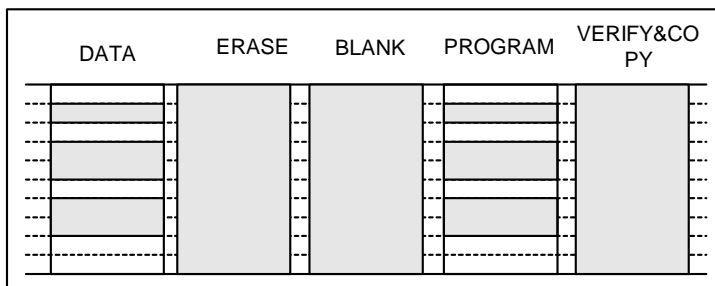

During mode setting, the device programmer automatically scans and detects sector blocks where data exists to set designated blocks. Then programming is targeted only to designated blocks. Erase, Blank Verify is targeted to all blocks.

[SINGLE PAE]

The following three parameters can be set in PAE mode.

“Dev start” Operating start address (Device)

“Dev end” Operating end address (Device)

“Buf start” Operating start address (Buffer memory)

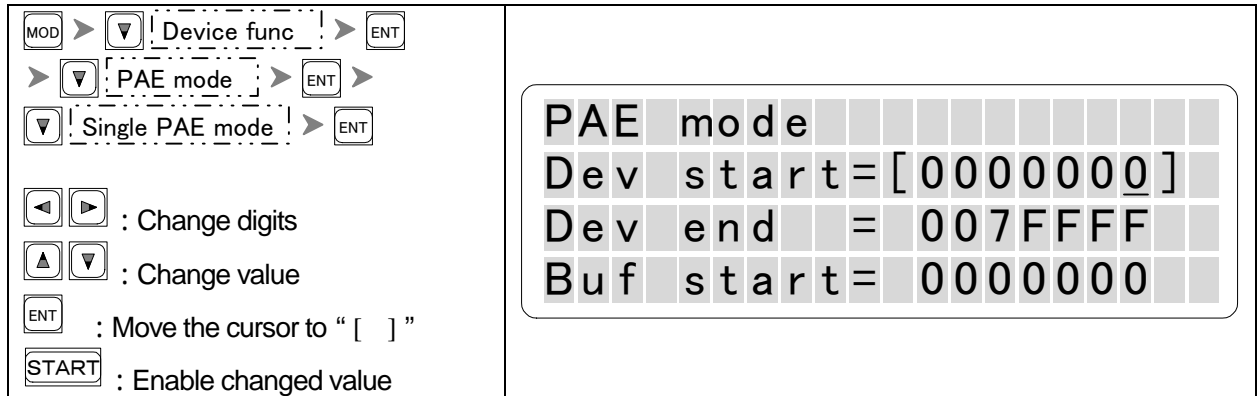

Warning : The units of device address is the same as the data length of the device.

The unit of buffer address is fixed as one byte (8bits). Please make a note of this especially for 16-bit device.

Example)

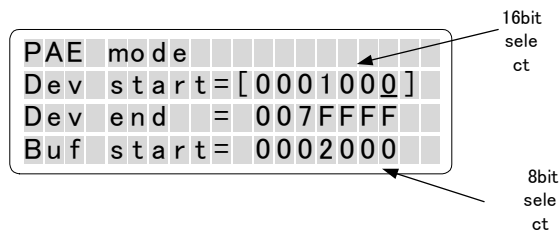

When device code is changed and power is turned on/off, it is changed to default.

Remarks : The last two digits of address can not be changed on the device supporting page programming mode.

Some device prohibits to use a part of the address.

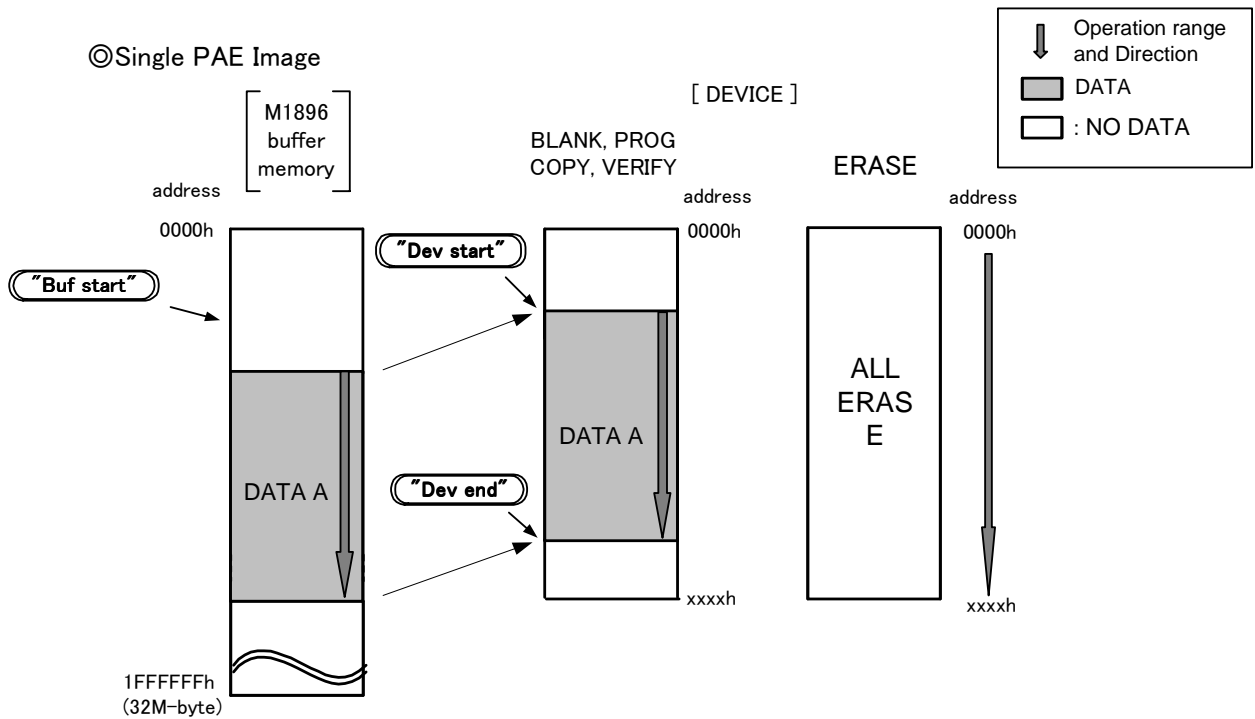

When address is changed, "P" for this mode is indicated on the display panel.

(Please refer to how to read the display)

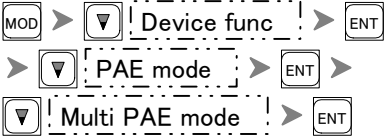

[Multi PAE]

Multi PAE detects data by sector blocks and enables to program only blocks where data should be in, (During mode setting, data is automatically scanned. Targeted blocks to be programmed are automatically set after the scanning)

<p>  </p> <p>  : DATA is scanned and the number of designated blocks is displayed. When start key is pushed, Mode and block information is displayed. </p> <p>When the mode is successfully completed, M is indicated on the upper middle of the display.</p>	<div data-bbox="734 537 1436 772"> <p>Multi PAE Auto Scan</p> <p>scanning now....</p> <p>Block [10/64]</p> </div> <div data-bbox="734 806 1436 1041"> <p>Multi PAE mode</p> <p>Enable = 15/64</p> <p>blocks</p> <p>OK -> START key</p> </div> <div data-bbox="734 1086 1436 1310"> <p>BLANK M N 16bitx 1</p> <p>intel cd:0E0875</p> <p>E28F320S5</p> <p>SU816</p> </div>
<p>※Mode is cancelled if there is not any valid data (Other than \$FF)</p>	<div data-bbox="734 1388 1436 1624"> <p>Multi PAE mode</p> <p>-- Canceled --</p> <p><< no valid data >></p> <p>Hit any key!!</p> </div>

©Multi PAE Image

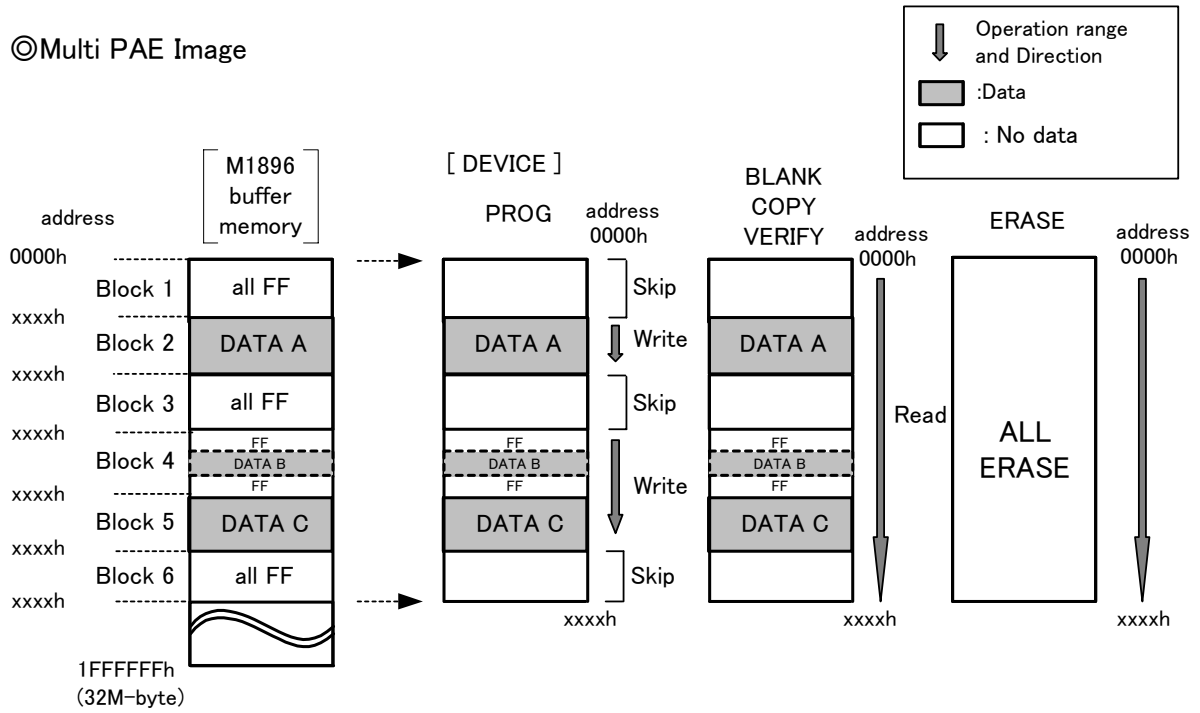

Remarks : Set mode is cleared out when new device code is selected.

When data is changed after setting the mode, Please set the mode once again.

Information of the block

<p> </p> <p>At Multi PAE setting as above Pressing enables to display designated blocks</p>	
<p> : Move the cursor : Enable changed value : Change display </p>	

At the display of the block indicator,
 Block address area can be displayed by moving underlined cursor.
 The following is the detail of each.

Contents of the display	
ADRS : 0078000-007FFFF	Display the address where the cursor is located.
B : 15	Display the number of blocks with cursor.
* : 6	Display the number of blocks being set
0-063	Display the total number of blocks can be set.
000 : ** 010 :****.. 020 :	Asterisk indicates designated blocks to be programmed. Period indicates blocks without a designation to be skipped during programming

How to clear PAE MODE

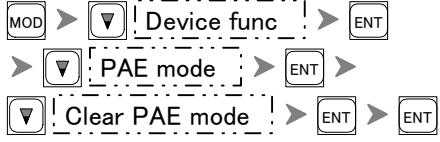
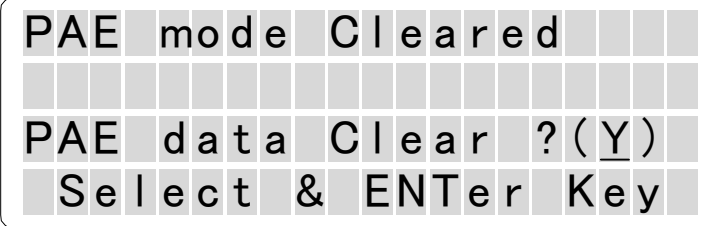
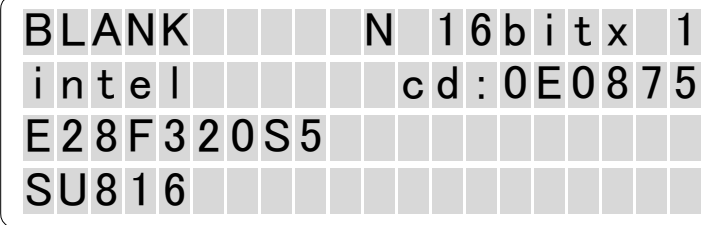
 <p>PAE MODE is cleared, When PAE data clear? is displayed Press the enter key.</p>	
<p>PAE mode is cleared when 'M' on display is disappeared</p>	

© Remote command

Remote command		
PAE Expand	PAE,start,end,offset	Setting single PAE(To sent start & end address and offset) Current Setting is applied-using default value
	PAE	Read back of current setting
	PAE,---	Cancel PAE(Return to default value)
	PAE,DIS	Cancel PAE(Return to default value)
	PAE,ENB	Move to single PAE Setting is unchanged. In case of normal to PAE, this is not valid.
	PAE,MLT	Move to Multi PAE mode Scanning memory during PAE mode setting to set programming Condition. If there is no data,error occurs.
	PAE,MOD	To rerurn current PAE mode setting EXAMPLE DIS : Standard mode ENB : Single PAE mode MLT 2 : Multi PAE applying block erase(program)

Read Vcc — Change device read voltage —

Usually voltage applied to the device for BLANK and VERIFY check is set with $\pm 10\%$ based on VCC voltage of COPY. These checks are targeted for different purpose. Sometimes some devices require more severe read and other checks and vice versa.

Default value (Standard value : VCC voltage for copy)

- BLANK : Standard Value -10%
- VERIFY(L) : Standard Value -10%
- VERIFY(H) : Standard Value $+10\%$

MOD > [v] Device func > ENT >

[v] Read VCC > ENT

[u] [d] : Change value

ENT : Move the cursor

START : Enable changed value

Read Vcc Select

BLANK : [4.50 V]

VERIFY_L : 4.50 V

VERIFY_H : 5.50 V

Remarks : The range is $-20\% \sim +20\%$ and it can be changed in 5%

VCC voltage for COPY can not be changed.

The value is changed to the default when device code is changed and the power is turned on/off.

When mode is changed, "C" for mode change is displayed on the display panel.

(Please refer to how to read the display)

Warning : The value should not exceed the standard value of the device in the data sheet.

List of voltage selection

When Copy_VCC = 3.3V

Voltage selection (v)		
	3.90 (+20%)	
	3.75 (+15%)	
	3.60 (+10%)	VERIFY_H
	3.45 (+5%)	
COPY	3.30 (0%)	
	3.15 (-5%)	
BLANK	3.00 (-10%)	VERIFY_L
	2.85 (-15%)	
	2.70 (-20%)	

When COPY_VCC = 5V

Voltage selection (v)		
	6.00 (+20%)	
	5.75 (+15%)	
	5.50 (+10%)	VERIFY_H
	5.25 (+5%)	
COPY	5.00 (0%)	
	4.75 (-5%)	
BLANK	4.50 (-10%)	VERIFY_L
	4.25 (-15%)	
	4.00 (-20%)	

Verify pattern — Changing the number of verify —

This is to change the check pattern of Vefiry.

“ default ”, “ 1 time ”, “ 2 times ” can be selected.

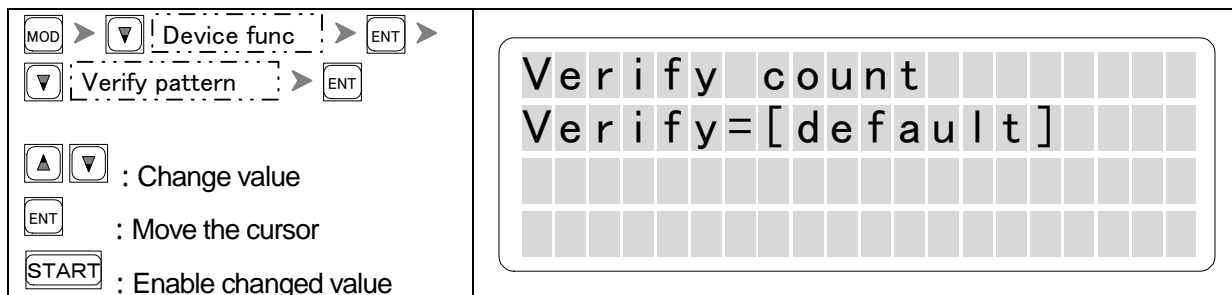

Remarks : Usually it is set as "default"

When device code is changed or the power is turned on/off. It is changed to "default"

When setting is changed, "V" for this mode is displayed. (Please refer to how to read the display)

Device type and check pattern

Parameter	E-PROM type	EE-PROM / FLASH type
Default	Default	Default
1 time	VF3	VF3
2 time	VF2 VF3	VF2 VF3

ID Check — Setting of ID check function —

Usually device ID check is carried out at COPY and PROG, etc operation to avoid a mixture of different devices. This function can be turned off.

<p> MOD > ▾ Device func > ENT > ▾ ID Check > ENT ▲ ▾ : Change value ENT : Move the cursor START : Enable changed value </p>	
---	--

Setting and the operation of M1896

Setting	Operation of M1896
ON	Device ID check is carried out (default)
OFF	Device ID check is skipped.

Remarks : Usually it is set as "default"

When device code is changed or the power is turned on/off. It is changed to "default"

Remarks : Some device code is skipped ID Check.

Protect mode — Setting of device data protect mode —

Some FLASH memories have protected mode. When this feature is used, this mode should be changed. These devices have area to store programming data and protected information. The area for programming data is called “main memory area” and the area for protected data is called “protected area”. The default is “No operat”

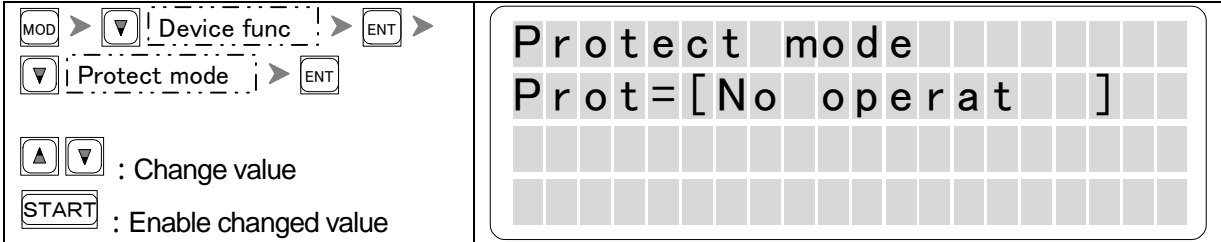

Remarks : Some supplier call protected area as “Sector –Protect” or “Block-Lock”.

When device code is changed or the power is turned on/off, the setting is changed to default.

Warning : If the device currently selected does not have protect feature, LCD displays “Protect not support”

In order to protect data, protect area must be specified.

(This chapter : Please refer to Protect Setting)

Mode and access area

Mode	Access area	Mode display
No operat (NO OPERATION)	Only main memory area (Default)	“ N ”
Prot only (PROTECT ONLY)	Only protect ed area	“ P ”
Unprot/Prot (UNPROTECT/PROTECT)	Main memory, Protected area	“ U ”

Remarks : A sign that indicated current mode is shown on LCD. (Please refer to how to read display)

Outlook protect mode setting

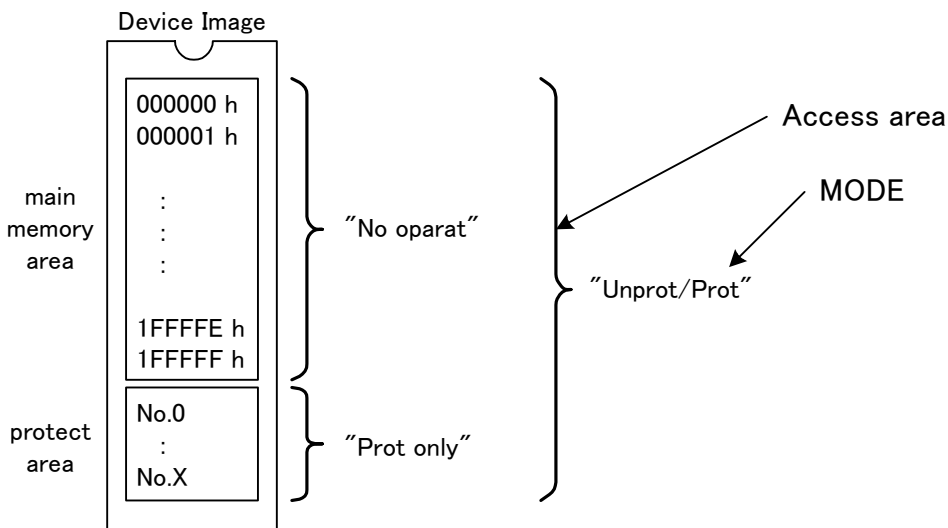

CONT operation flow chart when Unprot/Prot is set (FLASH)

Basically the flow is same.however turning to access to protected area in each mode is added.
 in case of PROG, the sequence of access is main memory protected area.

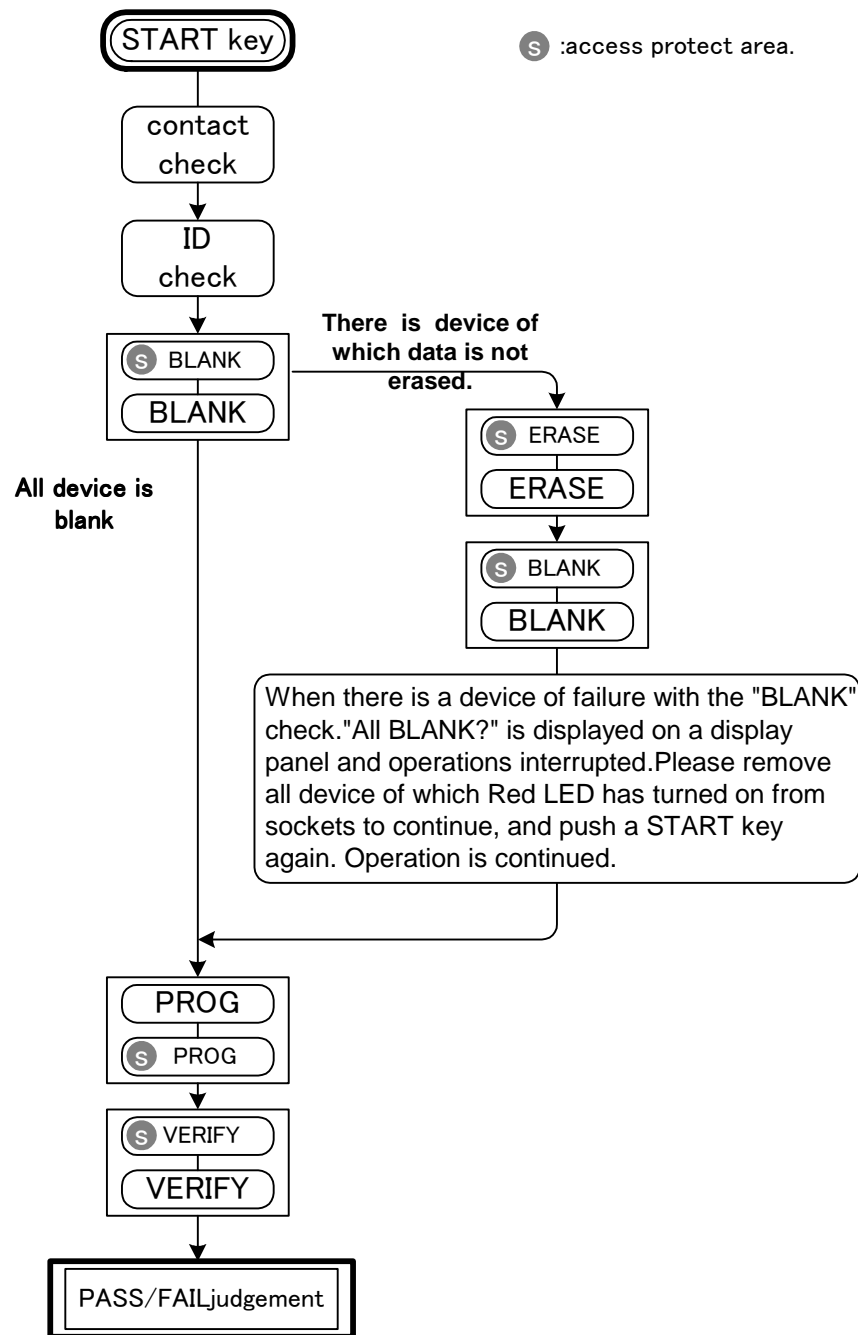

Access timing to protected area on other mode shch as "COPY", "BLANK" is added.
 In case of PROG, it accesses to main memory first. Then goes on to protected area.

CONT operation flow chart when Prot only is set.(FLASH)

Basically the flow is the same, however access to main memory is changed to access to protect area.

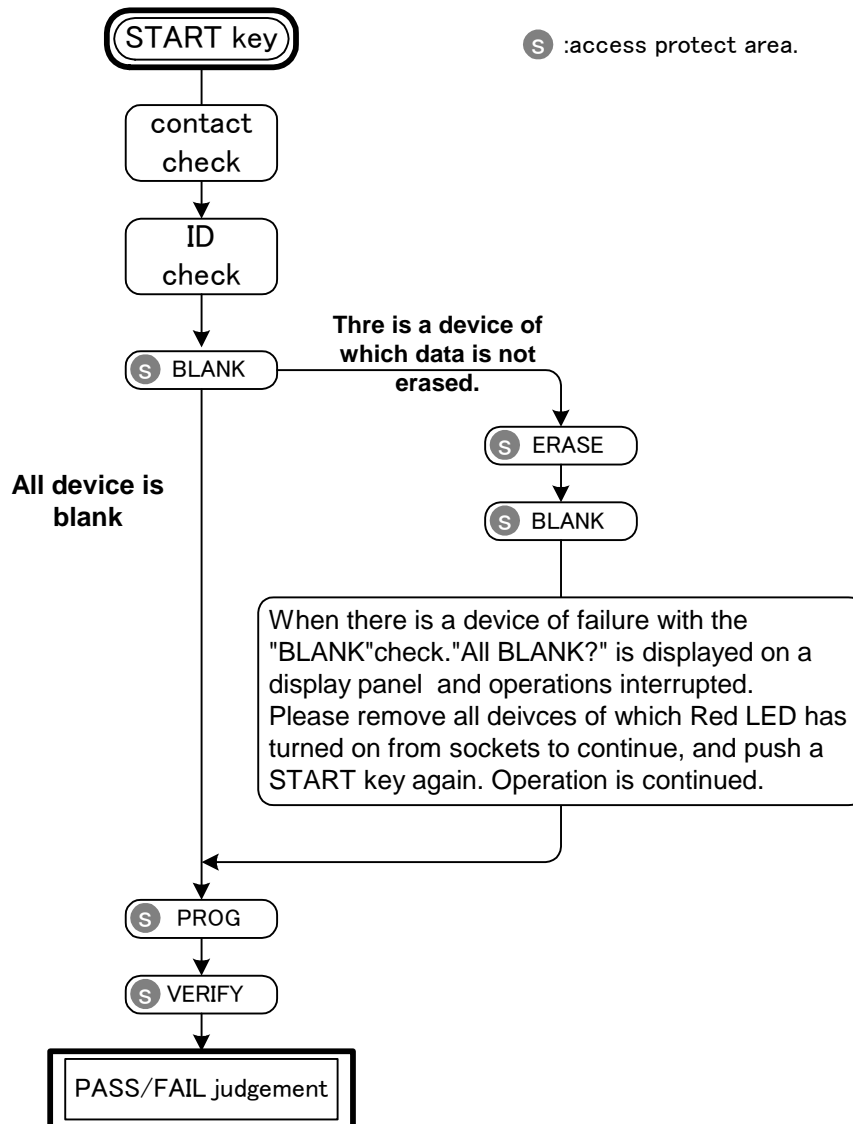

Access timing to protected area on other mode such as "COPY", "BLANK" is added.

Protect setting — To change protect setting for protected data —

In order to apply protection a device, not only protect mode setting but also the targeted protect area should be selected. This is called "Protect data set". The protect failure of M1896 is designed to set Protect/Unprotect of each individual area. The default setting is all "Un Protect".

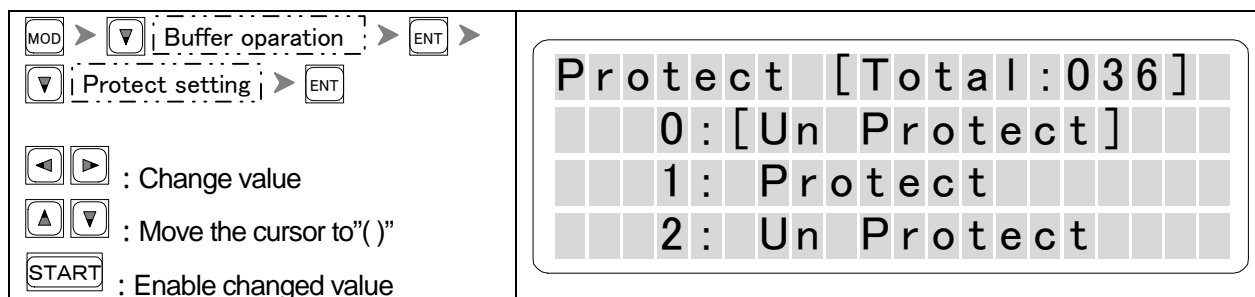

Remarks : Above display is the select screen of "Spansion 32M S71PL032JXX".

"0;" "1;" "2;" indicates the number of protect area."0;" means "sector 0" or "block 0" in the data sheet.

"Protect" should be selected for the number to protect and "Un protect" should be selected for the number not to protect. On above screen, "TOTAL 36" means there are 36 of protecting area.

When device code is changed and the power is turned on/off, the setting is changed to default value.

Warning : This area and configuration of protect is different on each device. Please check data sheet first.

Some devices do not have this feature.

If currency selected device does not support protect feature, "Protect not support!" is displayed on LCD.

In order to erase protected data, "ERASE" should be executed.

Repeat mode — Setting of repeat mode —

Repeat operation of "COPY", "BLANK" and so forth can be set.
 Either (off) or (Fail stop) can be selected. Usually the setting is "off".

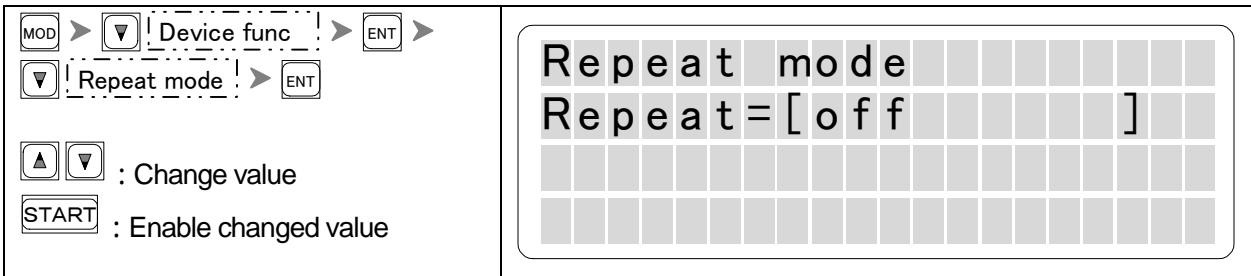

Remarks : There is no indication to indicate repeat mode.

Operation of M1896 (example : VERIFY CHECK)

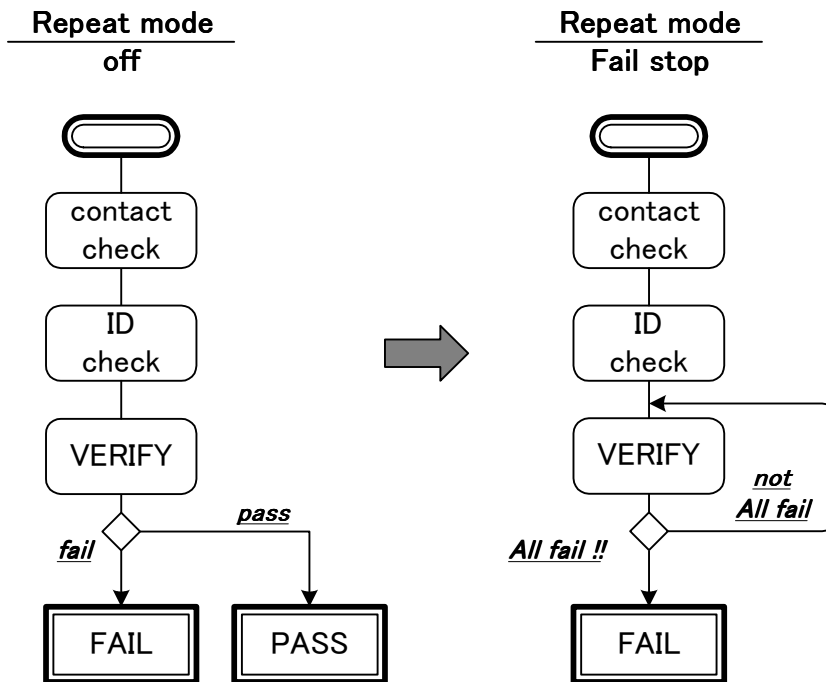

Remarks : Only very first contact check is executed.
 When "FAIL stop" is set, all socket "FAIL" stop the operation.

Set Prg mode — Programming different data on multiple devices —

In advance operation of M1896, There is a mode called "Set Program".

Usually the same data is programmed in devices set on the socket. If "Set Program Mode" is applied, a memory module that consists of different devices can be programmed just by one operation.

Select set mode (Memory data length and Address size and multiplier) to set the configuration of the module.

Data appropriate for the module should be stored in the buffer memory.

<div style="border: 1px solid black; padding: 2px; margin-bottom: 5px;"> MOD > Device func > ENT > </div> <div style="border: 1px solid black; padding: 2px; margin-bottom: 5px;"> Set Prg mode > ENT </div> <div style="margin-bottom: 5px;"> ▲ ▼ : Change value </div> <div style="margin-bottom: 5px;"> ENT : Move the cursor to " [] " </div> <div> START : Enable changed value </div>	<div style="border: 1px solid black; padding: 10px; width: fit-content; margin: 0 auto;"> <table style="border-collapse: collapse; font-family: monospace; font-size: 1.2em;"> <tr><td style="padding: 2px 5px;">S</td><td style="padding: 2px 5px;">e</td><td style="padding: 2px 5px;">t</td><td style="padding: 2px 5px;"> </td><td style="padding: 2px 5px;">p</td><td style="padding: 2px 5px;">r</td><td style="padding: 2px 5px;">o</td><td style="padding: 2px 5px;">g</td><td style="padding: 2px 5px;">r</td><td style="padding: 2px 5px;">a</td><td style="padding: 2px 5px;">m</td><td style="padding: 2px 5px;">m</td><td style="padding: 2px 5px;">i</td><td style="padding: 2px 5px;">n</td><td style="padding: 2px 5px;">g</td><td style="padding: 2px 5px;"> </td><td style="padding: 2px 5px;">m</td><td style="padding: 2px 5px;">o</td><td style="padding: 2px 5px;">d</td><td style="padding: 2px 5px;">e</td></tr> <tr><td style="padding: 2px 5px;">D</td><td style="padding: 2px 5px;">a</td><td style="padding: 2px 5px;"> </td><td style="padding: 2px 5px;">b</td><td style="padding: 2px 5px;">i</td><td style="padding: 2px 5px;">t</td><td style="padding: 2px 5px;">:</td><td style="padding: 2px 5px;">[</td><td style="padding: 2px 5px;">1</td><td style="padding: 2px 5px;">6</td><td style="padding: 2px 5px;">b</td><td style="padding: 2px 5px;">i</td><td style="padding: 2px 5px;">t</td><td style="padding: 2px 5px;">]</td><td style="padding: 2px 5px;"> </td><td style="padding: 2px 5px;"> </td><td style="padding: 2px 5px;"> </td><td style="padding: 2px 5px;"> </td><td style="padding: 2px 5px;"> </td><td style="padding: 2px 5px;"> </td></tr> <tr><td style="padding: 2px 5px;">B</td><td style="padding: 2px 5px;">l</td><td style="padding: 2px 5px;">o</td><td style="padding: 2px 5px;">c</td><td style="padding: 2px 5px;">k</td><td style="padding: 2px 5px;"> </td><td style="padding: 2px 5px;">:</td><td style="padding: 2px 5px;"> </td><td style="padding: 2px 5px;">x</td><td style="padding: 2px 5px;"> </td><td style="padding: 2px 5px;">1</td><td style="padding: 2px 5px;"> </td><td style="padding: 2px 5px;"> </td><td style="padding: 2px 5px;"> </td><td style="padding: 2px 5px;"> </td><td style="padding: 2px 5px;"> </td><td style="padding: 2px 5px;"> </td><td style="padding: 2px 5px;"> </td><td style="padding: 2px 5px;"> </td><td style="padding: 2px 5px;"> </td></tr> </table> </div>	S	e	t		p	r	o	g	r	a	m	m	i	n	g		m	o	d	e	D	a		b	i	t	:	[1	6	b	i	t]							B	l	o	c	k		:		x		1									
S	e	t		p	r	o	g	r	a	m	m	i	n	g		m	o	d	e																																										
D	a		b	i	t	:	[1	6	b	i	t]																																																
B	l	o	c	k		:		x		1																																																			

Remarks : This mode can not be set with "PAE mode"

When "Set Prg mode" is set, "PAE mode" is changed to default (with message).

When "PAE mode" is set "Set Prg mode" becomes invalid (without message)

Setting exceeding buffer size of M1896 can not be set.

It operates under little endian method as the standard operation.

◎List of mode

Data with of Selected device	Mode (Data length of module x Blocks)
8 b i t	8 b i t x 1
	8 b i t x 2
	8 b i t x 4
	8 b i t x 8
	1 6 b i t x 1
	1 6 b i t x 2
	1 6 b i t x 4
	3 2 b i t x 1
	3 2 b i t x 2
1 6 b i t	1 6 b i t x 1 N
	1 6 b i t x 2 N
	1 6 b i t x 4 N
	1 6 b i t x 8 N
	3 2 b i t x 1 N
	3 2 b i t x 2 N
	3 2 b i t x 4 N

◎ Set mode and the image of module (8bit-Device)

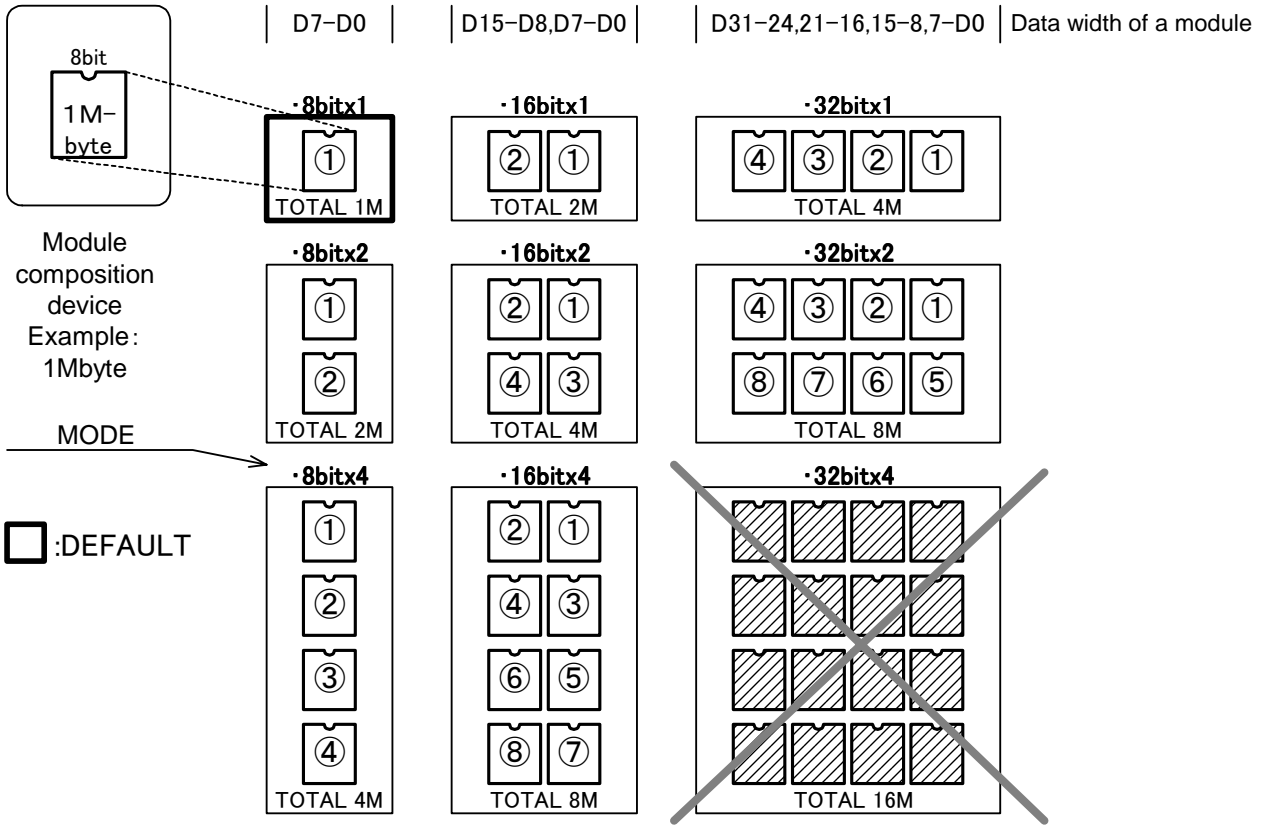

Warning :Only one type of device for the module can be selected.
Maximum number of device to be used is 8 pieces.

◎Correspondence among the configuration of the module(16 bit x2), buffer memory and position of device.

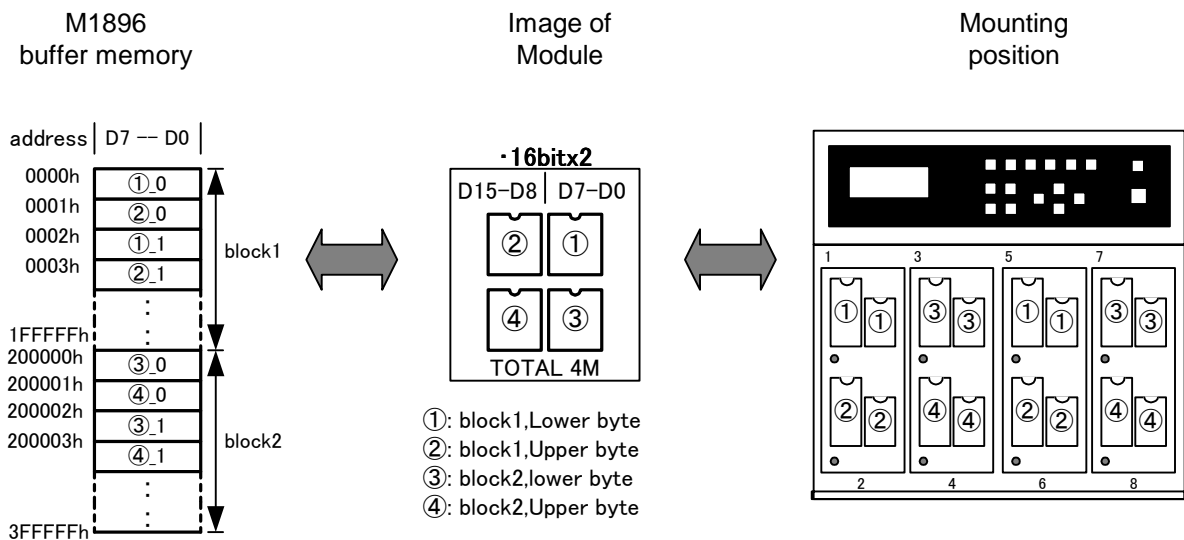

©Set mode and the configuration of the module (16bit-Device)

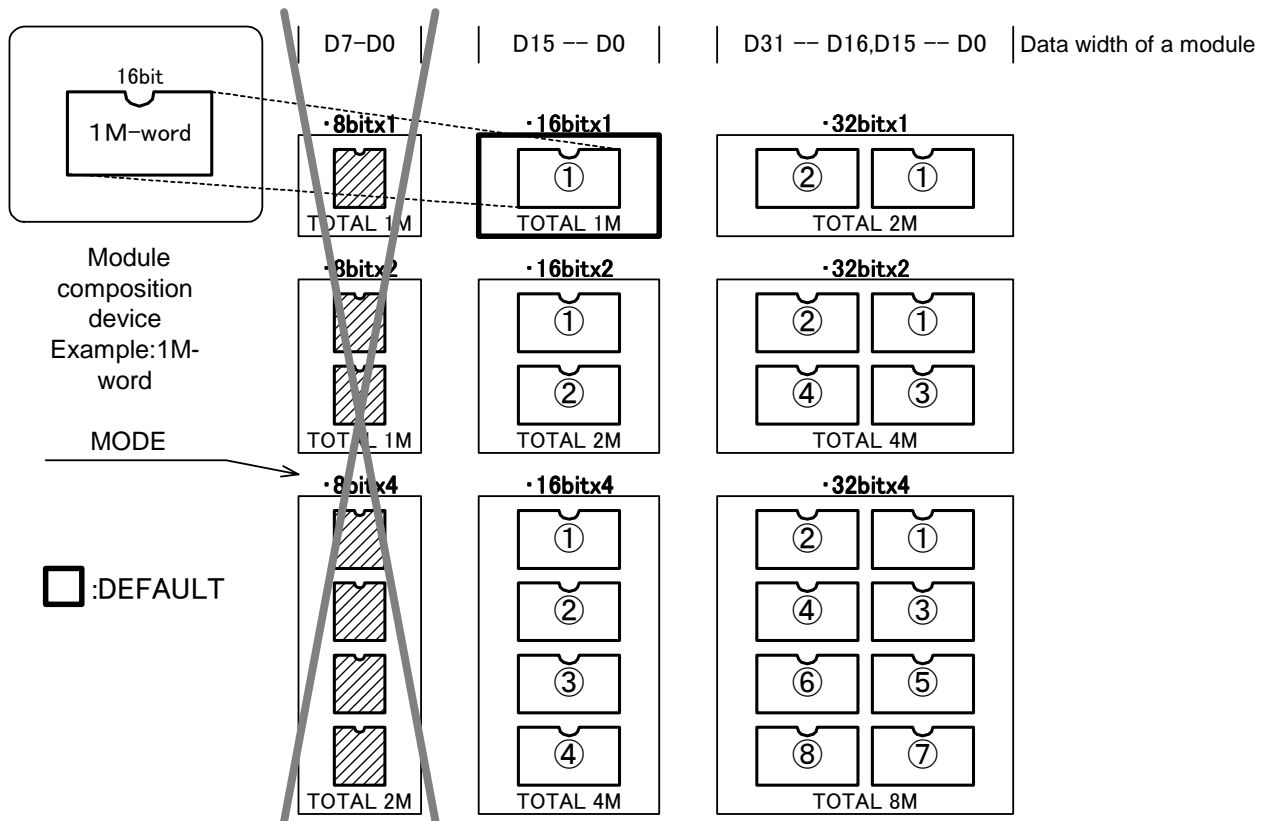

© Correspondence among the configuration of the module(16bit × 2), buffer memory and position of device.

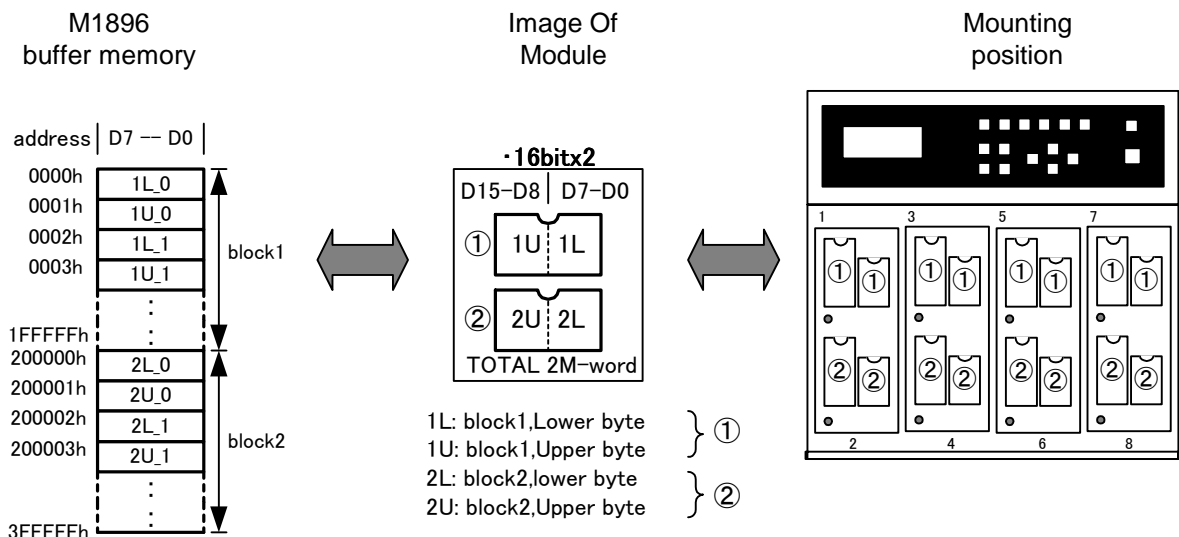

Remarks : Access under little endian mode

Copy socket when Set program mode is selected

With standard operation, only #1 socket was valid for COPY, when "Set Prg mode" is set, you can COPY master ROM data from multiple socket according to selected mode.

Copy data is stored in each buffer memory.

Set mode and Copy socket

Data width of Selected device	Set mode (Data width mode x Blocks)	COPY socket	Remarks
8 b i t	8 b i t x 1	# 1	Normal operation
	8 b i t x 2	# 1 , # 2	
	8 b i t x 4	# 1 - # 4	
	8 b i t x 8	# 1 - # 8	
	1 6 b i t x 1	# 1 , # 2	
	1 6 b i t x 2	# 1 - # 4	
	1 6 b i t x 4	# 1 - # 8	
	3 2 b i t x 1	# 1 - # 4	
3 2 b i t x 2	# 1 - # 8		
1 6 b i t	1 6 b i t x 1 N	# 1	Normal operation
	1 6 b i t x 2 N	# 1 , # 2	
	1 6 b i t x 4 N	# 1 - # 4	
	1 6 b i t x 8 N	# 1 - # 8	
	3 2 b i t x 1 N	# 1 , # 2	
	3 2 b i t x 2 N	# 1 - # 4	
	3 2 b i t x 4 N	# 1 - # 8	

When COPY is executed with one device.

Set program mode recognize multiple devices as one device. For example, the following is the operation To "8bit x 4" mode according to above table and execute COPY with master ROM on socket #3.

Contact check

As there is no device set on #1,2,4 sockets, COPY is stopped at contact check.

To continue the operation, press START once again.

COPY data

Master ROM data is stored in buffer memory area of #3 socket.

Buffer memory area of #1,2,4 is **overwritten with "FFh"**

Results

Since 4 devices were supposed to be used, it is regarded as FAIL as a whole.

When COPY of master ROM of #3 socket is completed correctly, green light is lit on #3 LED.

Red light on #1,2,4 is lit. Other LED is not lit.

When COPY is executed with less number of devices, the same transaction is observed.

Monitor mode — Checking of Nand device setting —

On M1896, Bad block information of Nand device can be checked by remote on monitor.

<p> <input type="button" value="MOD"/> > <input type="button" value="▼"/> Device func > <input type="button" value="ENT"/> > <input type="button" value="▼"/> Monitor mode > <input type="button" value="ENT"/> </p> <hr/> <p> <input type="button" value="▲"/> <input type="button" value="▼"/> : Change value <input type="button" value="START"/> : Enable changed value </p>	<div style="border: 1px solid gray; padding: 10px; text-align: center;"> <p>Monitor Mode</p> <p>Monitor = [Off]</p> </div>
--	--

Select Mode

Mode	
Monitor mode	OFF (Default)
	ON

Make sure if communication of RS-232C or USB is operated normally.

It is operated only using remote application. Remote mode(Ctrl+E Ctrl+E) is not need to executed.

```

## NAND Module Ver 4.00 ##
DEVICE = 128Mb
DATA FURM = FORMAT
PAE MODE = 0
BAD BLOCK = FF FF FF FF FF F0 FF FF FF FF FF FF FF FF
BAD CHECK = FF (05)
Bad Info Pages = 1
BLOCK = 1004 / 1024

## Bad Block List ##
SK [ 0001] = 900
## End ##
BB SCAN ; ○ | _ | _ | _ | _ | _ | _ | _ |
Verify 2 ; ○ | _ | _ | _ | _ | _ | _ | _ |
Verify 3 ; ○ | _ | _ | _ | _ | _ | _ | _ |
    
```

Remarks: When device code is changed or the power is turned on/off , it is changed to “default”

MEMORY

MEMORY	69
Little endian mode	69
Buffer Init (initializing buffer memory data)	70
Buffer DUMP/EDIT (Dumping and editing buffer memory data) ..	71
Byte Swap (Buffer memory data byte swap)	72
Word Swap (Word swap of buffer memory data)	73
Check SUM (Calculation of add and sum)	74
CRC16/32 Calculaiton (Calcuration of CRC16/32)	75

Memory

This is to explain the operation to change the setting of the buffer memory and memory data edit on M1896.

Little endian mode — LITTLE ENDIAN —

Internal buffer memory of M1896 is based on a Byte(8bit). When data that was based on byte method (8bit) in internal buffer is used for word(16-bit) method, M1896 operates in little endian mode. Therefore, it required editing of buffer data. When you program a device using COPY data from master ROM, buffer edit is not required.

◎8bit Device

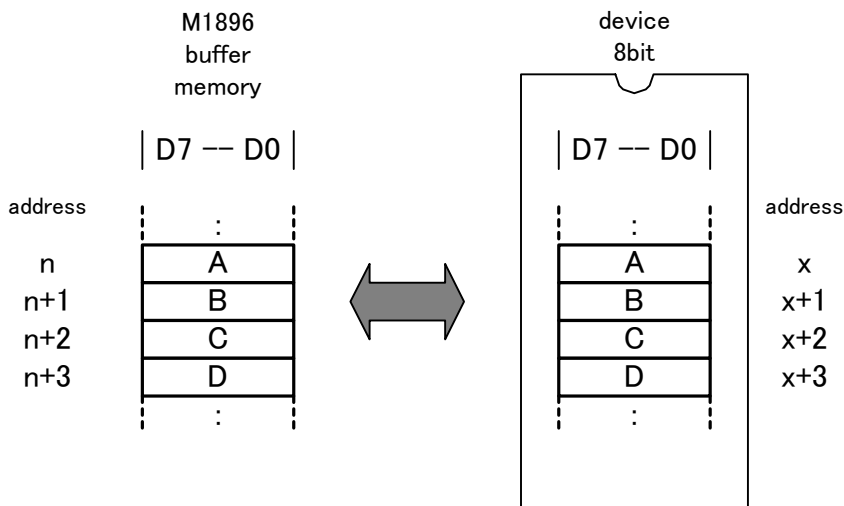

◎16bit Device

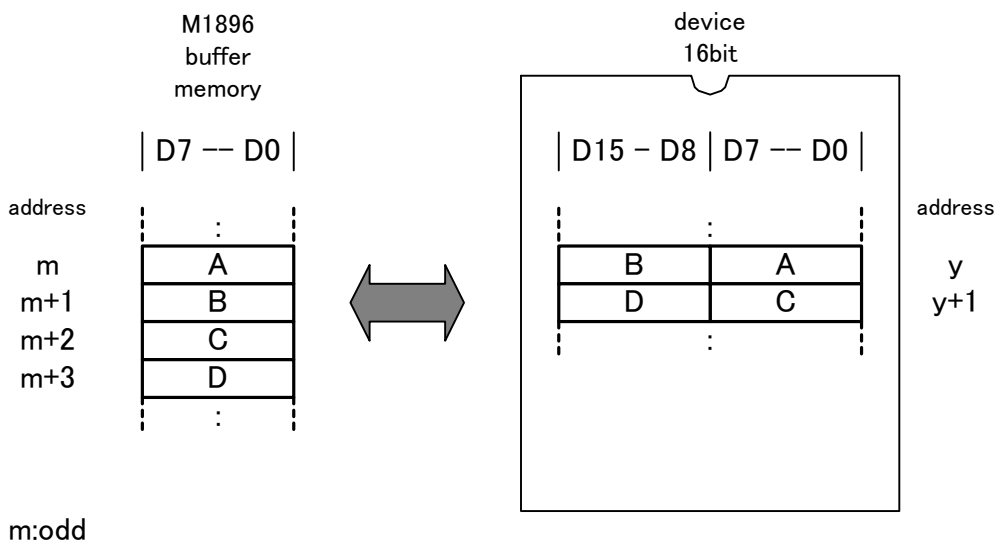

Buffer init — Initializing buffer memory data —

This is the initialize buffer memory data.

Four pattern "All FFh", "All 00h", "03,060C,...", "00,00,FF,..." can be selected.

Regardless of device size, a certain targeted portion of buffer memory of M1896 can be initialized.

MOD > Buffer operation > ENT >
 Buffer init! > ENT

▲ ▼ : Change value
 ◀ ▶ : Move digits
 ENT : Move the cursor to
 START : Execute initialization

Buffer initialize
 Start: [0000000]
 End : 1FFFFFFF
 Ptrn : All FFh

Pattern and initializing data

Pattern	Data (hex)
All FFh	" FF "
All 00h	" 00 "
03,06,0C, ...	"03,06,0C,18,30,60,C0,.....Repeat
00,00,FF, ...	"00,00,FF,FF,00,00,FF,.....Repeat

Buffer Dump — Dumping and editing buffer memory data —

This is a feature to check and edit the contents of the buffer memory data

Dumpling (Dump)

MOD > ▼ | Buffer operation | > ENT >

▼ | Buffer DUMP/EDIT | > ENT

◀ ▶ : Change digit
▲ ▼ : Change address

ADDRESS	0000000	DUMP
0000000	FF FF FF FF	
0000004	FF FF FF FF	
0000008	FF FF FF FF	

↕ COM : editor mode/ change dump mode

Change data (Edit)

◀ ▶ : Change digit
▲ ▼ : Change data

Remarks : When up/down key is pressed, data is renewed with a message.

ADDRESS	0000000	EDIT
0000000	[FF]FF FF FF	
0000004	FF FF FF FF	
0000008	FF FF FF FF	

BYTE SWAP — Buffer memory data word swap —

Swapping buffer memory data per word.
Swapping whole buffer memory area.

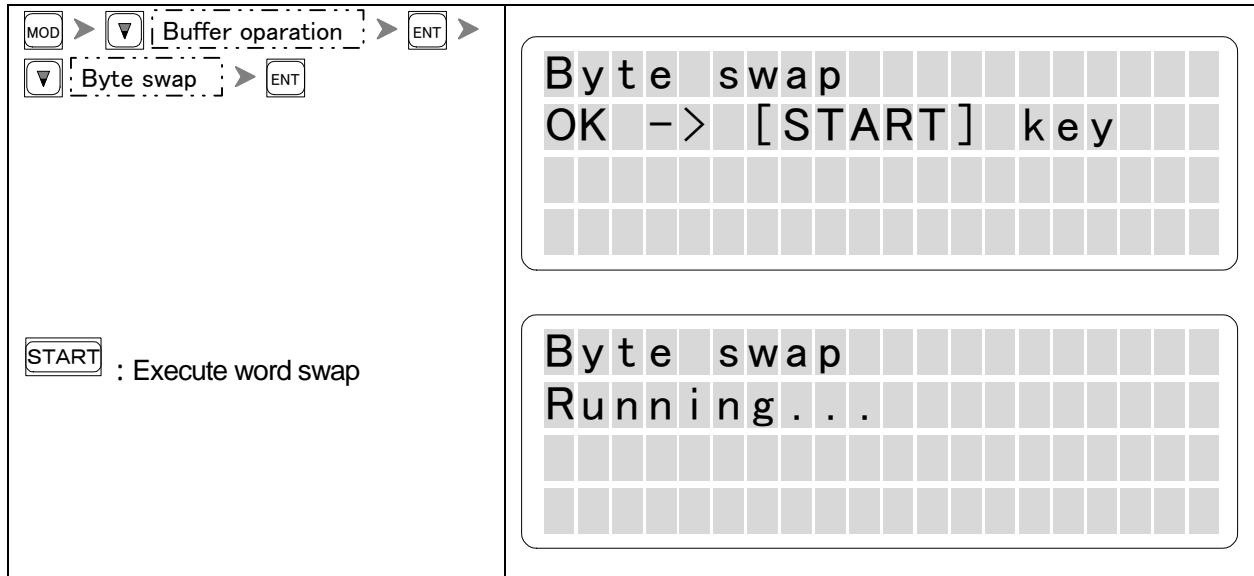

Remarks : When it is completed, the display is changed to initial screen.

Check data with "BUFFER DUMP/EDIT" function.

Operation: MOD > [▼] Buffer operation > ENT > [▼] Buffer DUMP/EDIT > ENT

©Byte Swap Image

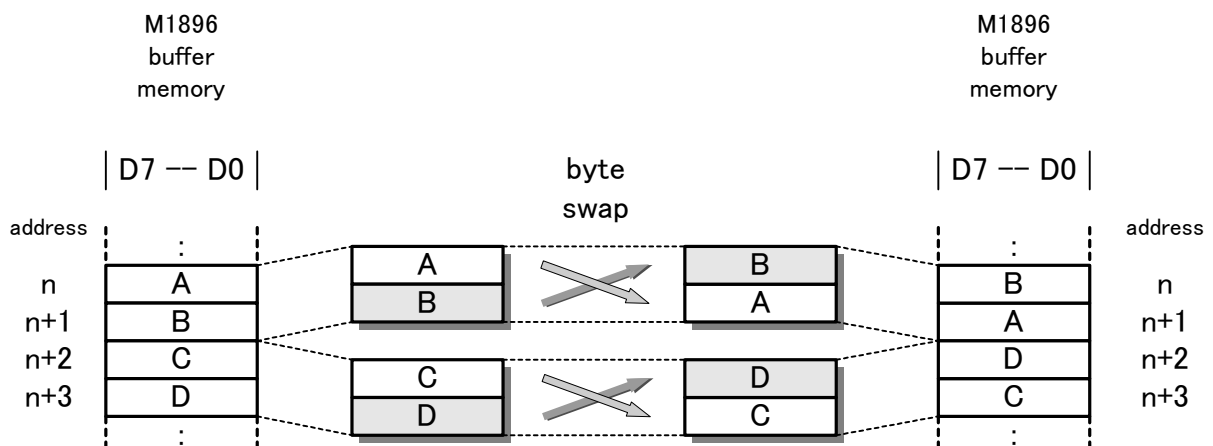

n:odd

Word swap — Buffer memory data word swap —

Swapping buffer memory data per word.
Swapping whole buffer memory area.

MOD > ▼ Buffer operation > ENT >
 ▼ Word swap > ENT

Word swap

OK -> [START]

START : Execute word swap

Word swap

Running...

Remarks : When it is completed, the display is changed to initial screen.

Check data with "BUFFER DUMP/EDIT" function.

Operation : MOD > ▼ Buffer operation > ENT > ▼ Buffer DUMP/EDIT > ENT

©Word Swap Image

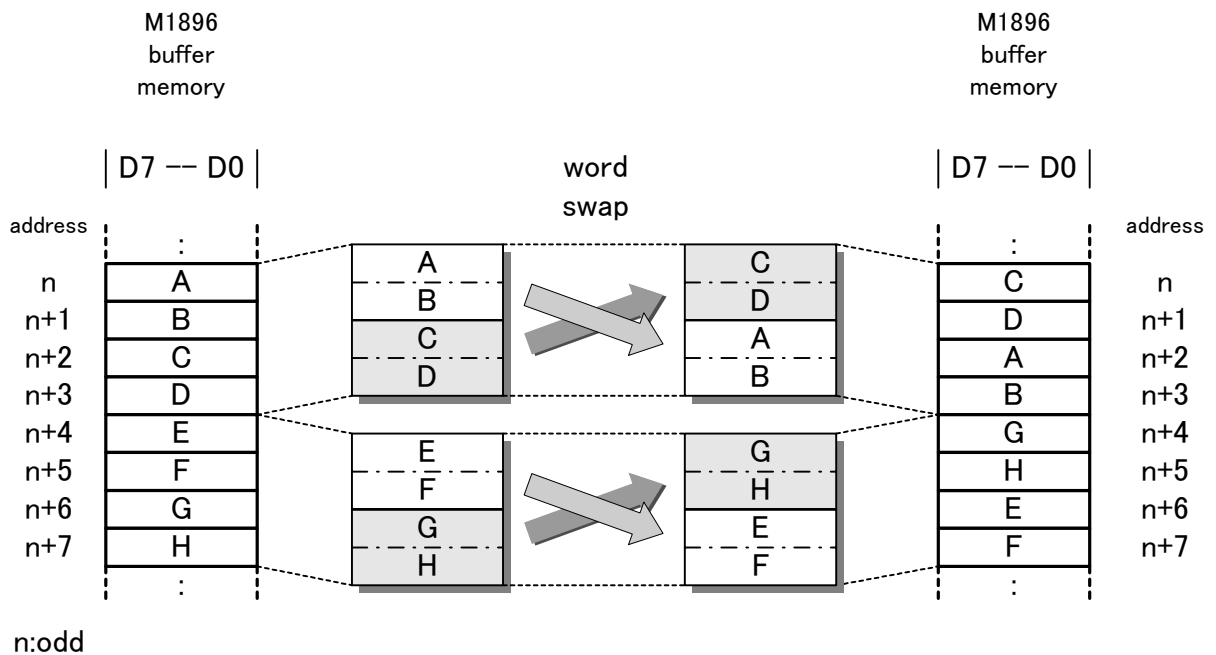

Check sum — Calculation of add and sum —

To calculate the operating buffer memory data of the targeted device in add and sum at byte (8bit).

MOD > ▼ | Buffer operation > ENT >
▼ | Check sum > ENT

START : Execute calculation

Applicable buffer address of the operating buffer memory to be calculated is displayed.
Press start after confirming the value for the targeted area.

Displaying results.
▲ ▼ : Checking SUM of each socket is displayed.

Check sum calc.

OK -> [START] key

Start adr=0000000

End adr=03FFFFFF

Check sum calc.

Calculating...

Start adr=0000000

End adr=03FFFFFF

Check sum calc.

Socket 1

SUM: 006CE0D

XOR: C3

Remarks : SUM ,XOR is calculated in byte(8 bit).

“PAE” setting is valid.

Please set device code before executing check SUM as the buffer address calculation area is different depending on the data length of the device.

Data length and calculation area of buffer address

Example) "PAE" setting (0000,1FFF,500)

Initialize pattern : in case (0000,1FFFFFFF, pattern FF)

Device data length	Address calculation area (hex)	result of check SUM (hex)
8 b i t	5 0 0 ~ 2 4 F F	0 0 1 F E 0 0 0、 0 0
1 6 b i t	5 0 0 ~ 4 4 F F	0 0 3 F C 0 0 0、 0 0

Example of calculation

Data line (hex)	SUM calculation (hex)	XOR calculation (hex)
1 st : A A	= A A	= A A
2 nd : 5 5	[A A] + 5 5 = F F	[A A] ^ 5 5 = F F
3 rd : A A	[F F] + A A = 1 A 9	[F F] ^ A A = 5 5

CRC16/32 Calc - Calculation of CRC16/32 Calc -

There is CRC16/32 algorithm as method for searching data unsequence.

M1896 has function only calculation of CRC16/32.

<p> <input type="button" value="MOD"/> > <input type="button" value="▼"/> Buffer operation > <input type="button" value="ENT"/> > <input type="button" value="▼"/> CRC 16 / 32 calc > <input type="button" value="ENT"/> > <input type="button" value="CRC [16]"/> > <input type="button" value="▼"/> > <input type="button" value="CRC [32]"/> </p> <hr/> <p> <input type="button" value="▲"/> <input type="button" value="▼"/> : Change value <input type="button" value="START"/> : Enable changed value </p>	<div style="border: 1px solid gray; padding: 10px; text-align: center;"> <p>CRC16 / 32 calculation</p> <p>Start = 0000000</p> <p>End = 01FFFFFF</p> <p>CRC [16] =</p> </div>
--	--

SELECT PARAMETER

ITEM	PARAMETER
CRC	16 , 32

SYSTEM

Device Check/ Buzzer / LED	77
Checking the firmware version of M1896	78
Updating the firmware version of M1896	79
Self check mode	81
Socket unit	82

Device Check / Buzzer / LED

Device Check mode

In order to avoid wrong insertion in the socket or device failure, device check(contact check) function is provided in M1896. However, device check could not work on some microcomputers with memory due to its complicity. When this kind of device is used, device check can be set as OFF. When it is turned OFF, each mode is automatically executed by pressing START. Please make sure that the direction of the device on the socket is correct. Otherwise, it may damage data device.

Buzzer mode

M1896 has a feature to let you know the send of an operation with a buzzer. Usually it is set as ON. When it is not required, please turn it OFF.

LED mode

M1896 has a feature to let you know the results of operation with LED light. Usually the socket without device(Empty Socket) is indicated with red LED. When this mode is OFF, LED is not lit for empty sockets.

The screenshot shows the 'System config' menu with 'Devchk/BZ/LED' selected. The settings are as follows:

Devchk/BZ/LED	settin
Buzzer mode	= [On]
Device check	= On
Empty LED	= On

Navigation controls:

- MOD > [Down Arrow] : System config > [ENT] >
- [Down Arrow] : Devchk/BZ/LED > [ENT]
- [Up Arrow] [Down Arrow] : Change value
- [ENT] : Move the cursor
- [START] : Enable changed value

Remarks : By pressing START key, the screen is turned to initial display with renewed setting.

Warning : When device code and the power is turned on/off, these settings are changed to default.

Mode	Setting
Buzzer mode	When the power is turned "ON"
Device check	When device code is changed and the power is turned "ON"
Empty LED	When the power is turned "ON"

Checking the firmware version of M1896

The firmware version of M1896 can be checked.

Model name(M1896), version, release date, installed memory are displayed.

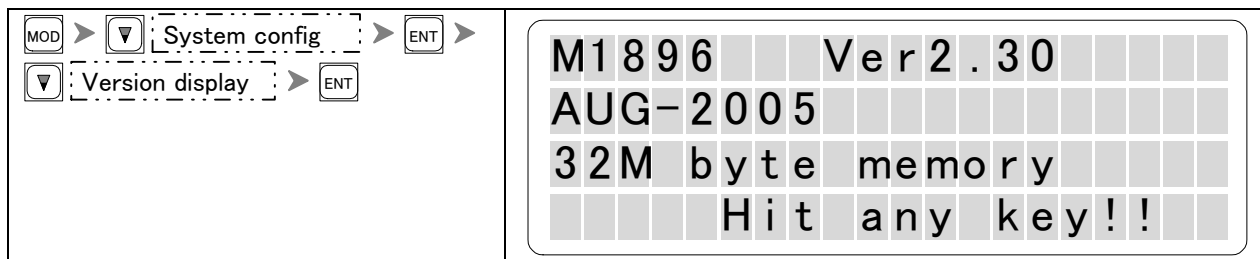

Updating the firmware

This is use to make an update of the firmware versions. in order to add new device algorithm which is newly supported.

Before UPDATE is executed, the memory must be initialized. Version up data load is required.

Preoperation

- 1 . Initialize the buffer memory of M1896 with “all FFh”.
- 2 . Load data for version-up in the buffer memory (from 0000)

The screenshot shows the device's menu system. On the left, a navigation tree is visible with 'System config' selected and 'System update' highlighted. Below this, a 'START' button is shown with the instruction ': Execute updating'. On the right, the main display shows the following text:

```
Update system M1896
New Update
OK -> START
NO -> RESET
```

Below this, a second display shows the update progress:

```
***update system***
update running...
Don't touch key !!
```

When version up data is not available, “key _code error “ is displayed.

After displaying above message, LED starts to blink.

As the process goes forward, LED is turned to green.

When all LED is turned to green, the version up is completed (the message on the display is unchanged).

When the update is completed ,M1896 automatically restart and execute self –check.After the self-check, confirm the version is updated.

Warning : When this operation is failed, M1896 does not work at all. For the update, please consult with Minato authorized distributor in your area.

Setting is to be default when version-up

Format Select	<p>MOD > [v] System config > ENT > [v] Data format > [v]</p> <p>format=[Intel Hex] : default</p>
Interface Select	<p>MOD > [v] Remote mode > ENT > [v] IF select > ENT</p> <p>Interface=[USB] : default</p>
Serial Config	<p>MOD > [v] System config > ENT > [v] RS config > ENT</p> <p> Serial Config </p> <p>BAUD RATE 19200 PARITY None CHARACTER 8 bit STOP BIT 2 bit CONTORL XOn/Off : default</p>
Remote mode config	<p>MOD > [v] Remote mode > ENT > [v] Remote config > ENT</p> <p> Remote mode config </p> <p>ECHO ON PROMPT # ACK/NAK OFF BZ MODE ON : default</p>
Selfcheck mode	<p>MOD > [v] System config > ENT > [v] Selfcheck mode > ENT</p> <p>check =[No Skip] : default</p>

Self check mode — Self check Skip/No skip —

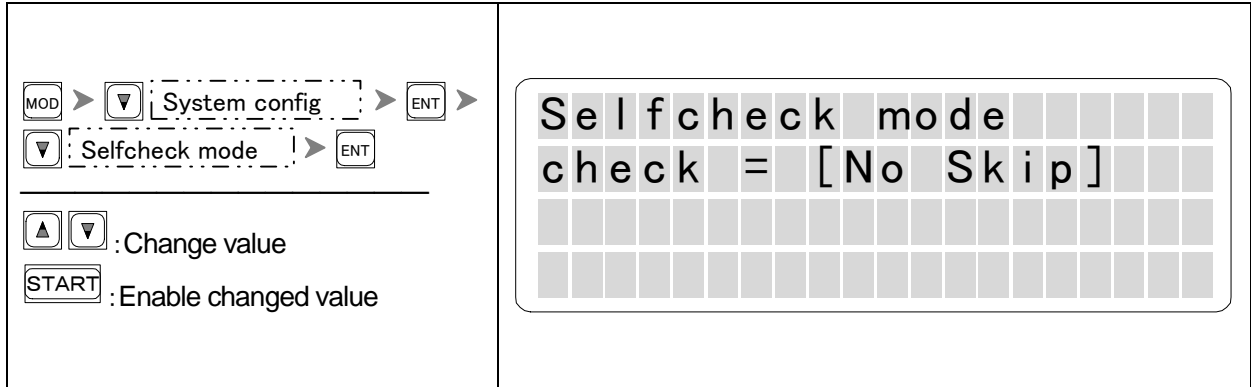

Item for setting

Item	Setting
Selfcheck	No skip (default)
	Skip

Remarks: Skip mode is skipped checking device socket except memory check.

This setting is valid even if the power is turned off.

When the firmware version is updated, it should be set once again.

Socket unit — Selecting socket unit —

Item name of socket unit is displayed.

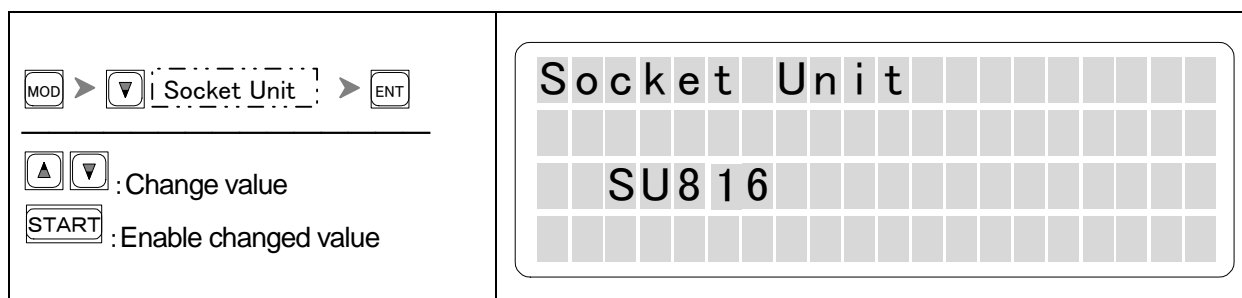

DATA TRANSFER

Data Transfer	84
RS Config(Setting interface configuration)	85
Data Format(Setting transfer data format)	86
Serial In (Data transfer : Serial input)	87
Serial out (Data transfer : Serial output)	88
Prtoect SR in(Protected data transfer: Serial input)	89
Protect SR out(Protected data transfer : Serial output)	90
Remote control	91
IF Select (Selection of an interface)	92
Remote Config(Setting the condition of remote mode)	93
Executing remote mode	95

Data Transfer

M1896 is equipped with RS-232C serial interface to communicate with external device.

When data is transferred from PC to the buffer memory through RS-232C, the remote control can be accomplished via command data. This is to explain data transfer.

Transferring command data (This chapter :Please refer to remote control)

To use these communication functions, the condition of the transfer must be preset.

Rs Config — Setting interface configuration —

How to set RS232C

When communicating with other device through RS232C, match the communication setting with the targeted device.

RS232C to connect with PC should be straight cable that is available in the market.

MOD > [v] System config > [ENT] >

[v] RS config > [ENT]

[▲] [▼] : Change value

[ENT] : Move the cursor “()”

[START] : Enable changed value

Serial Config

BAUD RATE [19200]

PARITY None

CHARACTER 8bit

Serial Config

CHARACTER 8bit

STOP BIT 2bit

CONTROL [None]

When START key is pressed, the display is changed to the initial screen with renewed setting.

Items for setting and parameters to beset

Items for setting	Parameters
BAUD RATE	9600,19200,38400,57600,115200 [bps]
PARITY	None, ODD, EVEN
CHARACTER	7, 8 [bit]
STOP BIT	1, 2 [bit]
CONTROLLE	None, Xon/Off, Rts/Cts

Remarks : This setting is valid even if the power is turned off.

When the firmware version is updated, it should be set once again.

“RS config” of setting is not needed when it is used by USB for interface.

Data Format — Setting transfer data format —

When data is transferred, not only the communication setting but also transfer data format must be set. Usually data format if data file must be set.

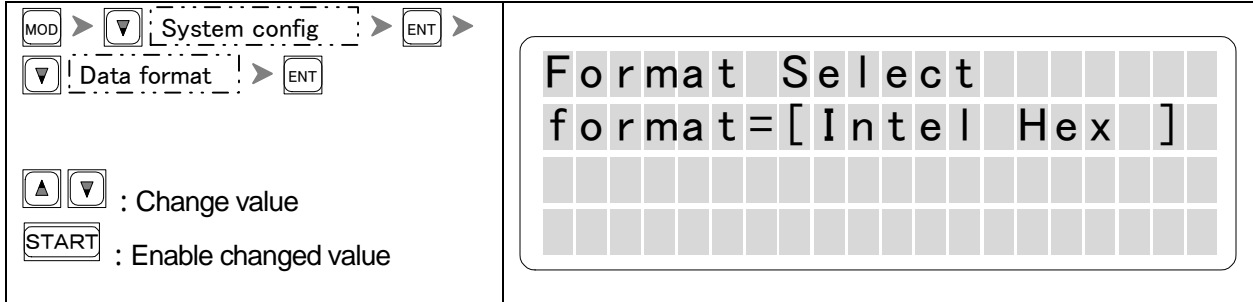

When start key is pressed, the display is changed to the initial screen with renewed setting.

Format to be selected and specification

Format Name	Data format	SUM	Address	End record
Minato Hex	ASCII	None	Including	Including
Intel Hex	ASCII	Including	Including	Including
Motorola S	ASCII	Including	Including	Including
HP64000ABS	Bin	Including	Including	Including
No Format	Bin	None	None	None

Remarks : This setting is valid even if the power is turned off.

When the firmware version is updated, it should be set once again.

Serial In — Data transfer : Serial input —

Serial I/F of M1896 become ready to receive. When data is received, it is stored in the buffer memory according to the transfer data format that was preset.

Start address in transfer data format can be specified. (Other data is ignored)

Store start address of the buffer memory can be specified.

MOD	>	▼	I/O Command	▶	ENT	▶
▼			Data SR In	▶	ENT	
▲	▼	: Change value				
◀	▶	: Change digit				
ENT	: Move the cursor “()”					
START	: Start receiving data					

D	a	T	r	a	n	s	f	e	r										
S	e	r	i	a	l														
s	t	a	r	t	=	[0	0	0	0	0	0	0	0]				
s	t	o	r	e	=		0	0	0	0	0	0	0	0					

◎Serial In Image

setting:
 Data **Start** Address = 2400h
 Buffer **Store** Address = 1000h

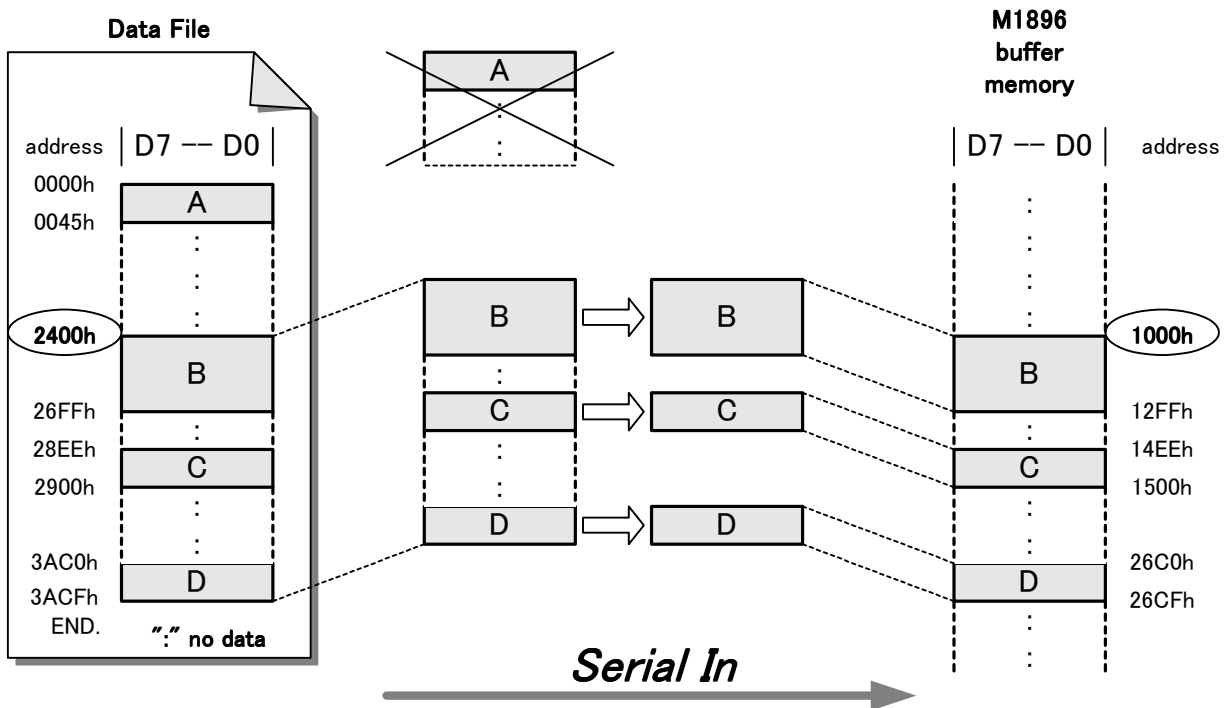

When transfer is completed, "COMPLETE" is displayed.

Serial out — Data format Serial output —

The data in the buffer memory of M1896 is transferred to external device through serial interface.
 The buffer data is converted and output according to the initial format setting.
 Store start address of the buffer memory can be specified.

MOD > I/O Command > ENT > Data SR Out > ENT ▲ ▼ : Change value ◀ ▶ : Change digit ENT : Move the cursor to “()” START : Data transfer is started	<table border="1"> <tr><td>D</td><td>a</td><td>t</td><td>a</td><td>T</td><td>r</td><td>a</td><td>n</td><td>s</td><td>f</td><td>e</td><td>r</td><td></td><td></td><td></td><td></td><td></td><td></td><td></td><td></td></tr> <tr><td>S</td><td>e</td><td>r</td><td>i</td><td>a</td><td>l</td><td>O</td><td>u</td><td>t</td><td></td><td></td><td></td><td></td><td></td><td></td><td></td><td></td><td></td><td></td><td></td></tr> <tr><td>s</td><td>t</td><td>a</td><td>r</td><td>t</td><td>=</td><td>[</td><td>0</td><td>0</td><td>0</td><td>0</td><td>0</td><td>0</td><td>0</td><td>]</td><td></td><td></td><td></td><td></td><td></td></tr> <tr><td>e</td><td>n</td><td>d</td><td></td><td>=</td><td></td><td></td><td>0</td><td>0</td><td>1</td><td>F</td><td>F</td><td>F</td><td>F</td><td></td><td></td><td></td><td></td><td></td></tr> </table>	D	a	t	a	T	r	a	n	s	f	e	r									S	e	r	i	a	l	O	u	t												s	t	a	r	t	=	[0	0	0	0	0	0	0]						e	n	d		=			0	0	1	F	F	F	F					
D	a	t	a	T	r	a	n	s	f	e	r																																																																					
S	e	r	i	a	l	O	u	t																																																																								
s	t	a	r	t	=	[0	0	0	0	0	0	0]																																																																		
e	n	d		=			0	0	1	F	F	F	F																																																																			

ⓄSerial Out Image

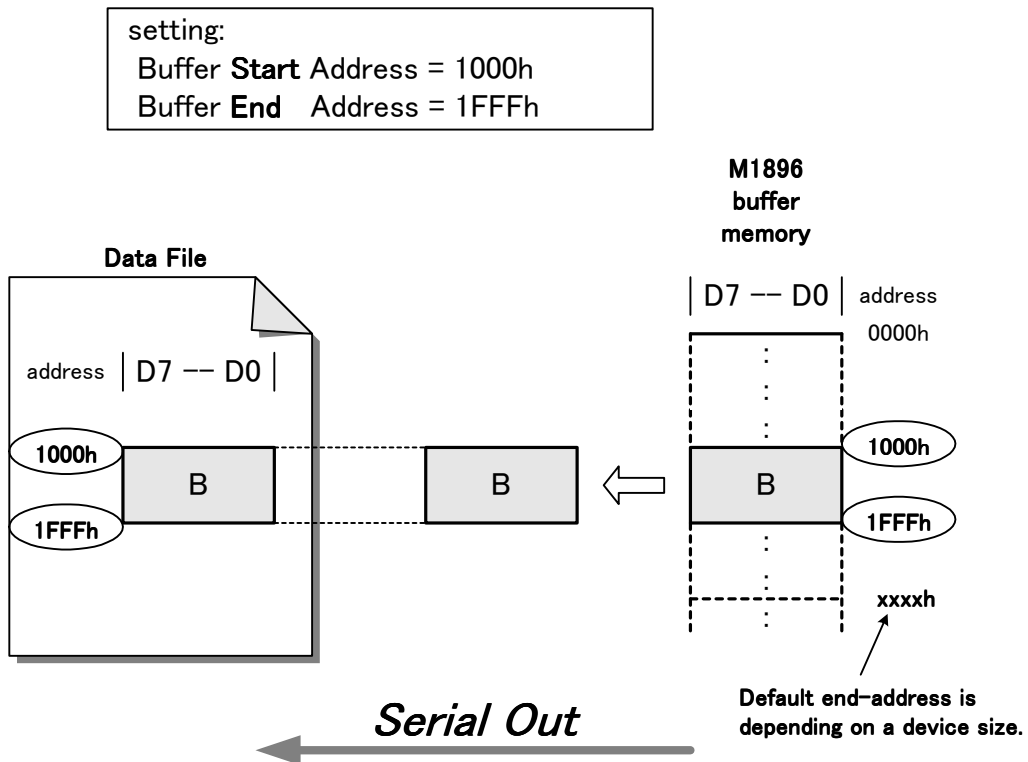

When transfer is completed, "COMPLETE" is displayed.

Protect SR in — Protected data transfer : Serial Input —

“Protect data “ is read in M1896 through serial interface.

The serial interface of M1896 becomes ready to receive. After that, received data is stored in the register for sector information according to the format that is current set.

Format data start address(protected area start number :hex)can be specified.

If currently selected device does not support this feature, protect function can not be applied.

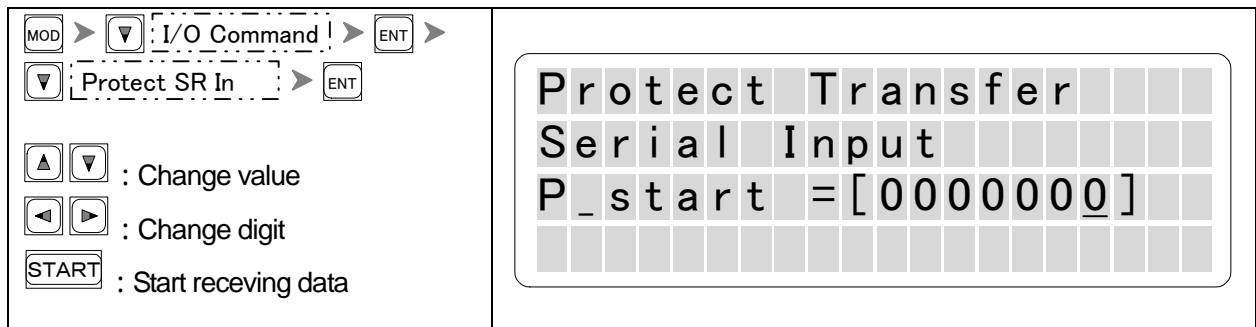

When transfer is completed, ""COMPLETE"" is displayed.

Protect SR out — Protected data transfer : Serial output —

“Protected data” is outputted to external device through serial interface.

The protected data is converted to the format that is currently set.

Parameter can not be changed. If currently selected device dose not support this feature, protect function can not be applied.

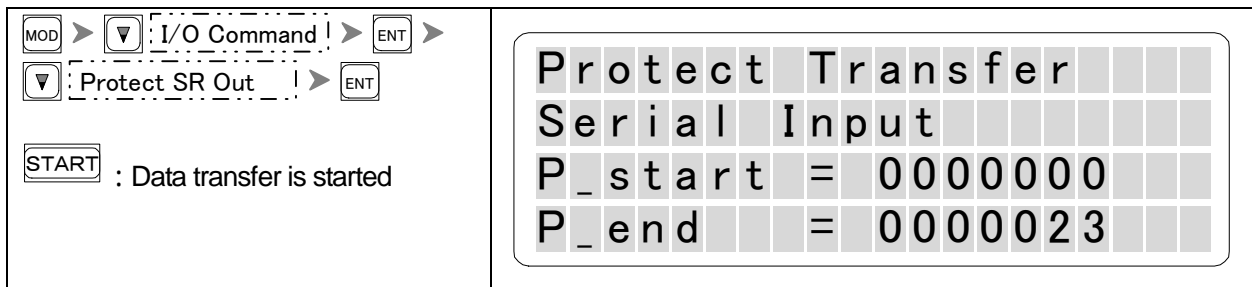

Parameter	Value(hex)
P_start	The start number of protected area (0)
P_end	The end number of protected area(It is different in each type of device)

Remarks : Parameter can not be changed.

Above message is the display screen to select “ Spansion 32M S71PL032Jxx

Above device have 36 protect area(number 0-35dec)

Parameter	Number (dec)	Number (hex)
P_start	0	0
P_end	35	23

When transfer data is completed,“”COMPLETE””is displayed.

Remote control

In addition to the key switch operation that has been described in former pages, M1896 can be operated by remote control by directly sending command from an external machine to M1896 through serial interface. Minato called it "Remote Control Mode of M1896" or "Remote Mode".

In order to use the feature of remote control, not only the condition of serial interface communication setting but also the condition of command transfer method must be set.

Serial interface communication setting (Communication function : Please refer to "Rs config")

This is to explain the setting on the panel operation and execution method.

If Select — Selection of an interface —

This is to select interface for the communication with other products.
RS-232C and USB can be selected. Default for shipment if USB

<p>MOD > ▼ Remote mode > ENT ></p> <p>▼ IF select > ENT</p> <p>▲ ▼ : Change value</p> <p>START : Enable changed value</p>	<pre> Interface select Interface=[USB] </pre>
---	--

Remarks : To use USB, USB driver must be installed in the PC. Please refer to M1896 USB driver install guide for the installation.

Selecting interface

Name	Interface
Interface	USB (default)
	RS232C

Remote config — Setting of the condition of remote mode —

The condition of remote mode is specified. ECHO,PROMPT,ACK/NAK,BZ-mode can be set.

<p> <input type="button" value="MOD"/> > <input type="button" value="▼"/> Remote mode > <input type="button" value="ENT"/> > <input type="button" value="▼"/> Remote config > <input type="button" value="ENT"/> </p> <p> <input type="button" value="▲"/> <input type="button" value="▼"/> : Change value <input type="button" value="ENT"/> : Move the cursor to "(" <input type="button" value="START"/> : Enable changed value </p>	<table border="1"> <tr><td>Remote</td><td>Config</td><td></td><td></td><td></td><td></td><td></td><td></td><td></td><td></td></tr> <tr><td>ECHO</td><td></td><td></td><td>[</td><td>ON</td><td></td><td></td><td>]</td><td></td><td></td></tr> <tr><td>PROMPT</td><td></td><td></td><td>#</td><td></td><td></td><td></td><td></td><td></td><td></td></tr> <tr><td>ACK/NAK</td><td></td><td></td><td>OFF</td><td></td><td></td><td></td><td></td><td></td><td></td></tr> </table> <table border="1"> <tr><td>Remote</td><td>Config</td><td></td><td></td><td></td><td></td><td></td><td></td><td></td><td></td></tr> <tr><td>PROMPT</td><td></td><td></td><td>#</td><td></td><td></td><td></td><td></td><td></td><td></td></tr> <tr><td>ACK/NAK</td><td></td><td></td><td>OFF</td><td></td><td></td><td></td><td></td><td></td><td></td></tr> <tr><td>BZ</td><td>MODE</td><td></td><td>[</td><td>ON</td><td></td><td></td><td>]</td><td></td><td></td></tr> </table>	Remote	Config									ECHO			[ON]			PROMPT			#							ACK/NAK			OFF							Remote	Config									PROMPT			#							ACK/NAK			OFF							BZ	MODE		[ON]		
Remote	Config																																																																																
ECHO			[ON]																																																																										
PROMPT			#																																																																														
ACK/NAK			OFF																																																																														
Remote	Config																																																																																
PROMPT			#																																																																														
ACK/NAK			OFF																																																																														
BZ	MODE		[ON]																																																																										

Explanation of parameter

“ ECHO ” (ECHO-back)

This is to select whether code that is sent from external machine is returned to external machine or not. Some special codes are ignored and are not effective for Echo back even if “ECHO on “ is set.

“ PROMPT ”

The character for “READY” status that indicates the end of a process of M1896 to external machine can be selected.

“ ACK/NAK ” (ACK knowledge/Negative -Acknowledge)

M1896 has a function to send ACK when data from external machine is received correctly and to send select whether you use this function or not.

ACK : ' A ' (41h)

NAK : ' N ' (4Eh)

“ BZ mode ” (Buzzer mode)

You can set a beep sound indicating finishing of each process. You can select whether you use this function or not.

There are a few setting of which parameters are fixed.

“TIME OUT”

A data input mode, TIME OUT function let the process stop if input is not observed through interface for certain period time.

“DUMMY READ”

This function is to skip reading received format data after end record is received. In case of M1896, it is fixed as “ON”.

“

Items to be selected and parameters

Items	Parameters
ECHO	ON,OFF
PROMPT	CR, LF, none
ACK/NAK	ON, OFF
BZ mode	ON, OFF

The following code in remote input command is treated as special code. Even with echo back is on, straightforward echo back can not be proceed.

Character		Process of M1896	Character		Process of M1896
	Hex code			Hex code	
NUL	00	—	DLE	10	—
SOH	01	—	DC1	11	XON
STX	02	—	DC2	12	—
ETX	03	—	DC3	13	XOFF
EOT	04	Cancel	DC4	14	—
ENQ	05	—	NAK	15	—
ACK	06	—	SYN	16	—
BEL	07	—	ETB	17	—
BS	08	Back space	CAN	18	—
HT	09	—	EM	19	—
LF	0A	—	SUB	1A	—
VT	0B	—	ESC	1B	—
FF	0C	—	FS	1C	—
CR	0D	Command terminator	GS	1D	—
SO	0E	—	RS	1E	—
SI	0F	—	US	1F	—
			DEL	7F	Back space

- : ignored

Executing Remote mode

Executing panel operation in remote mode

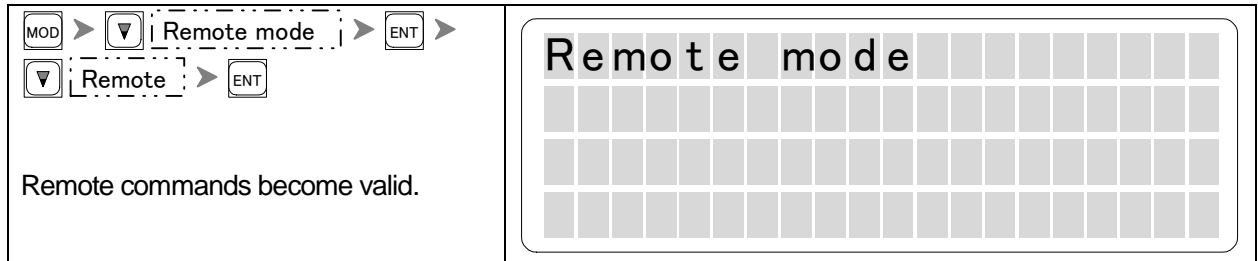

Execute remote mode from external machine

This is to input remote code from external machine that is connected with serial interface. When M1896 received remote mode, the above message is displayed and send prompt # to external terminal

Key board operation : Ctrl+E Ctrl+E
 ASCII (h e x): ENQ(05h) ENQ(05h)

Warning : Remote command can be received only when the initial display is shown.
 When it does not work, press reset key and input remote mode once again.

Outline of the execution of remote mode

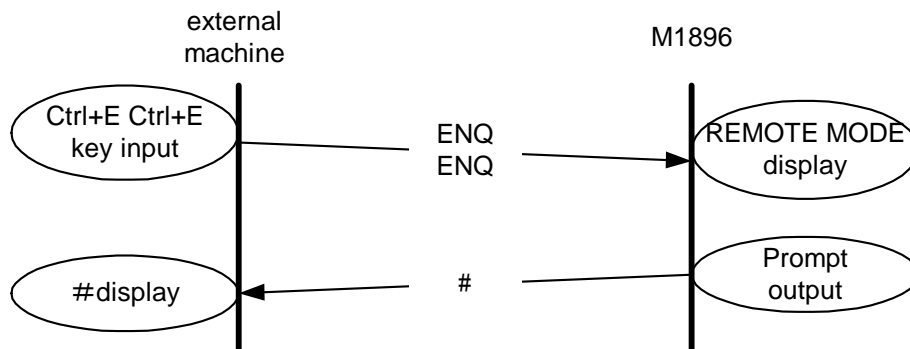

Remarks : In above drawing, PROMPT that is shown as “#” is preset as “#” in the condition of remote mode setting.

Prompt is differ from setting as below.

PROMPT : “ # ”	“ # ” out put
PROMPT : “ # CR LF ”	“ # CR LF ” out put
PROMPT : “ none ”	no output

REMOTE COMMAND

Caution of remote operation	97
How to read this chapter	98
Form of remote command	99
Signs to be used in remote command	100
Output forms of the results	101
List of commands	102
Explanation of the function	103

Caution of remote operation

Since operation of **COPY**, **BLANK**...etc. differs from the panel operation at the remote operation, be careful of the following points.

Although the execution is interrupted temporarily and it asks for removing the FAIL device with the contact check FAIL at the panel operation, it is not interrupted and continued at the remote operation, and so there is a possibility of damaging a device because of the high voltage being given to the device pin or an over current flowing.

In order to avoid these accidents, execute **CK** command(contact check command) and confirm no error is occurred before using **OP(COPY)**,**BL(BLANK)** command in remote.

→Reference: “**Ck**” (this chapter)

When **BLANK** check becomes fail in **CONT** operation, in panel operation it asks to halt the operation and remove failed device. In remote operation, it does not ask it and the device is regarded as bad device.

→Reference: “**CONT**”(Basic Operation)

→Reference: “**CT**”, “**OT**”(this chapter)

When remote application software XP-ROM for M1896 is used, ID check is set as OFF at the boot-up of the remote. When other application for remote is used, please be aware of the following.

When ID check fail is occurred **COPY**,**PROG** ,etc operation, the output format will be as follows.

Output format (total 30bytes、 example BL(BLANK) command)

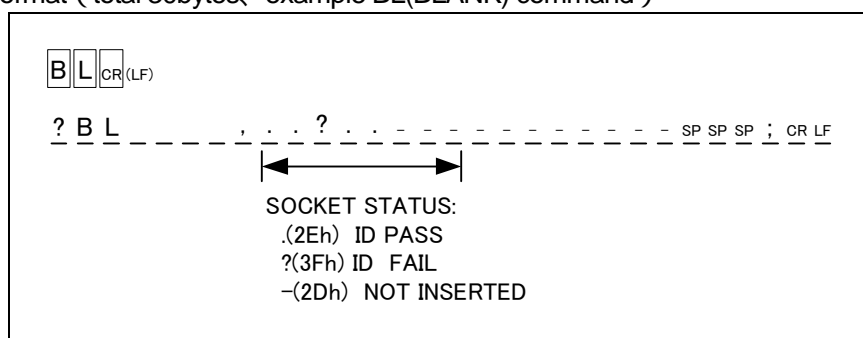

When above output is not used. change the check"OFF" using **SIG** command.

→Reference: “**SIG**”(this chapter)

For the detail of the XP-ROM, please check with Minato distributor.

How to read this chapter

	Title	Outview of this section																																																																																																																																																																																																			
	<p style="text-align: center;">RL — Serial I/F Data Input —</p> <p>It carries out data inputting for Serial/(RS-232C) on the remote mode. At first, M1896 changes Serial I/F into a mode for data input. When receiving RL command Once data is received, the data is converted according to Data Format (S,DF-com) and stored in the buffer memory. A start and end address of their formatted data for inputting and a start address of the buffer memory for storing can be set.</p>																																																																																																																																																																																																				
Explanation of Parameters	<p style="text-align: center;">COMMAND</p> <div style="border: 1px solid black; padding: 2px; width: fit-content; margin: 0 auto;">RL, P1, P2, P3</div>																																																																																																																																																																																																				
Default value of Parameters	<p>Parameters:</p> <p>P1: Formated Data Start Address (Formated Data) P2: Formated Data End Address (Formated Data) P3: Data Store Start Address (Buffer Memory)</p>																																																																																																																																																																																																				
Remarks	<p>Default Value (hex):</p> <p>P1: 00 P2: 1FFFFFFh (with 32M-bytes buffer memory) P3: 00</p>																																																																																																																																																																																																				
Caution	<p>Remarks: The setting that exceeds the address range of the buffer memory cannot be set.</p> <p>Caution: Datas cannot be loaded only with RD command input. In addition to that, it is necessary to transmit the formatted data from the external equipmtnet to M1896</p>																																																																																																																																																																																																				
	<p style="text-align: center;">■ Receiving</p> <div style="border: 1px solid black; padding: 10px; margin: 0 auto;"> <table style="width: 100%; border-collapse: collapse;"> <tr> <td style="border: 1px solid black; padding: 2px;">R</td> <td style="border: 1px solid black; padding: 2px;">L</td> <td style="border: 1px solid black; padding: 2px;">,</td> <td style="border: 1px solid black; padding: 2px;">P1</td> <td style="border: 1px solid black; padding: 2px;">P1</td> <td style="border: 1px solid black; padding: 2px;">P1</td> <td style="border: 1px solid black; padding: 2px;">P1</td> <td style="border: 1px solid black; padding: 2px;">P1</td> <td style="border: 1px solid black; padding: 2px;">P1</td> <td style="border: 1px solid black; padding: 2px;">P1</td> <td style="border: 1px solid black; padding: 2px;">,</td> <td style="border: 1px solid black; padding: 2px;">P2</td> <td style="border: 1px solid black; padding: 2px;">P2</td> <td style="border: 1px solid black; padding: 2px;">P2</td> <td style="border: 1px solid black; padding: 2px;">P2</td> <td style="border: 1px solid black; padding: 2px;">P2</td> <td style="border: 1px solid black; padding: 2px;">P2</td> <td style="border: 1px solid black; padding: 2px;">,</td> <td style="border: 1px solid black; padding: 2px;">P3</td> <td style="border: 1px solid black; padding: 2px;">P3</td> <td style="border: 1px solid black; padding: 2px;">P3</td> <td style="border: 1px solid black; padding: 2px;">P3</td> <td style="border: 1px solid black; padding: 2px;">P3</td> <td style="border: 1px solid black; padding: 2px;">P3</td> <td style="border: 1px solid black; padding: 2px;">P3</td> <td style="border: 1px solid black; padding: 2px;">CR</td> <td style="border: 1px solid black; padding: 2px;">(LF)</td> </tr> <tr> <td colspan="3"></td> <td colspan="7" style="text-align: center;">← P1: →</td> <td colspan="7" style="text-align: center;">← P2: →</td> <td colspan="7" style="text-align: center;">← P3: →</td> <td colspan="3"></td> </tr> <tr> <td colspan="3"></td> <td colspan="7" style="text-align: center;">Formatted data Start Address</td> <td colspan="7" style="text-align: center;">Formatted data End Address</td> <td colspan="7" style="text-align: center;">Buffer Start Address</td> <td colspan="3"></td> </tr> <tr> <td colspan="28" style="text-align: center;">: :</td> </tr> <tr> <td colspan="28" style="text-align: center;"><< Transmit the formatted data from the external equipment >></td> </tr> <tr> <td colspan="28" style="text-align: center;">: :</td> </tr> <tr> <td style="border: 1px solid black; padding: 2px;">P</td> <td style="border: 1px solid black; padding: 2px;">A</td> <td style="border: 1px solid black; padding: 2px;">S</td> <td style="border: 1px solid black; padding: 2px;">,</td> <td style="border: 1px solid black; padding: 2px;">R</td> <td style="border: 1px solid black; padding: 2px;">L</td> <td style="border: 1px solid black; padding: 2px;">SP</td> <td style="border: 1px solid black; padding: 2px;">SP</td> <td style="border: 1px solid black; padding: 2px;">SP</td> <td style="border: 1px solid black; padding: 2px;">SP</td> <td style="border: 1px solid black; padding: 2px;">SP</td> <td style="border: 1px solid black; padding: 2px;">SP</td> <td style="border: 1px solid black; padding: 2px;">SP</td> <td style="border: 1px solid black; padding: 2px;">SP</td> <td style="border: 1px solid black; padding: 2px;">SP</td> <td style="border: 1px solid black; padding: 2px;">SP</td> <td style="border: 1px solid black; padding: 2px;">SP</td> <td style="border: 1px solid black; padding: 2px;">SP</td> <td style="border: 1px solid black; padding: 2px;">SP</td> <td style="border: 1px solid black; padding: 2px;">SP</td> <td style="border: 1px solid black; padding: 2px;">SP</td> <td style="border: 1px solid black; padding: 2px;">SP</td> <td style="border: 1px solid black; padding: 2px;">SP</td> <td style="border: 1px solid black; padding: 2px;">SP</td> <td style="border: 1px solid black; padding: 2px;">SP</td> <td style="border: 1px solid black; padding: 2px;">SP</td> <td style="border: 1px solid black; padding: 2px;">SP</td> <td style="border: 1px solid black; padding: 2px;">;</td> <td style="border: 1px solid black; padding: 2px;">CR</td> <td style="border: 1px solid black; padding: 2px;">LF</td> </tr> </table> </div>		R	L	,	P1	P1	P1	P1	P1	P1	P1	,	P2	P2	P2	P2	P2	P2	,	P3	P3	P3	P3	P3	P3	P3	CR	(LF)				← P1: →							← P2: →							← P3: →													Formatted data Start Address							Formatted data End Address							Buffer Start Address										: :																												<< Transmit the formatted data from the external equipment >>																												: :																												P	A	S	,	R	L	SP	SP	SP	SP	SP	SP	SP	SP	SP	SP	SP	SP	SP	SP	SP	SP	SP	SP	SP	SP	SP	;	CR	LF
R	L	,	P1	P1	P1	P1	P1	P1	P1	,	P2	P2	P2	P2	P2	P2	,	P3	P3	P3	P3	P3	P3	P3	CR	(LF)																																																																																																																																																																											
			← P1: →							← P2: →							← P3: →																																																																																																																																																																																				
			Formatted data Start Address							Formatted data End Address							Buffer Start Address																																																																																																																																																																																				
: :																																																																																																																																																																																																					
<< Transmit the formatted data from the external equipment >>																																																																																																																																																																																																					
: :																																																																																																																																																																																																					
P	A	S	,	R	L	SP	SP	SP	SP	SP	SP	SP	SP	SP	SP	SP	SP	SP	SP	SP	SP	SP	SP	SP	SP	SP	;	CR	LF																																																																																																																																																																								
		120																																																																																																																																																																																																			

This shows the output from M1896.

Form of remote command

Input Form of The Remote Command

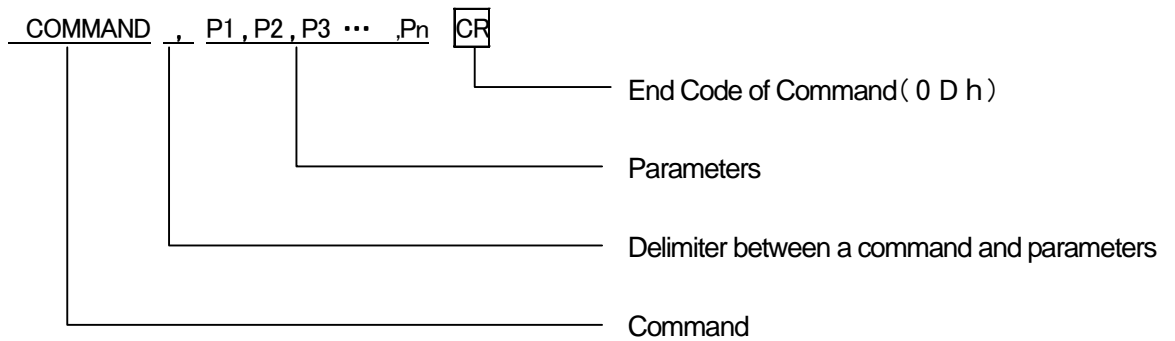

Remarks : All commands should be in capital letter.
: A number of parameter depends on commands

Elimination of parameter

When changing some parameters and not changing others with command that is needed some parameters, those commands that are not changed can be eliminated.

Basic Form	COMMAND, P1, P2, P3 <code>CR</code>
Elimination in case of changing P1 only	COMMAND, P1 <code>CR</code>
Elimiantion in case of changing P3 only	COMMAND, , , P3 <code>CR</code>

Signs to be used in remote command

Signs using in this chapter and for command input is defined as follows.

◎Definition of signs

[n]	A sign outputting from the external equipment and no Echo-Back from the programmer.
\boxed{n}	A sign outputting from the external equipment, and no Echo-Back from the programmer. (ECHO-Back is settable.)
(n)	A sign outputting from the programmer. (it will be outputted when ECHO-Back is ON, but not outputted when OFF.)
<u>N</u>	A sign outputting from the Programmer
SP	Space
CR	Carriage Return
LF	Line Feed(Skipping)
D1	XON
D3	XOFF

Output forms of the results

Output forms are divided into 2 kinds of command, operation commands and others. And each form is different.

Remarks : Operation commands.....They are commands those operate the device electrically, "COPY"
 "PROG", ...etc.

Others...They are commands those carry out several settings "PAE",
 "Buffer init", ...etc.

Output forms of the result (Operation commands)

◎ PASS END

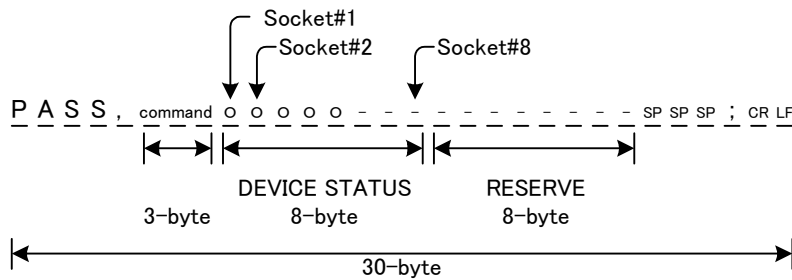

◎ FAIL END (Failure end)

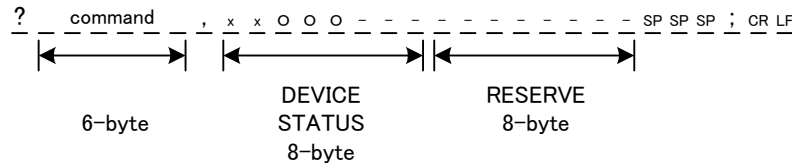

Output forms of the result (Others)

◎ PASS END

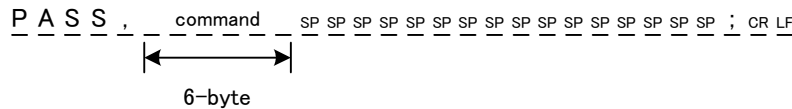

◎ FAIL END

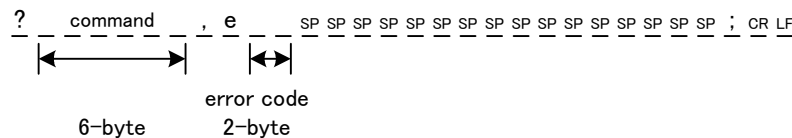

Remarks : SP...Space
 : CR...Carriage return
 : LF...Line Feed

List of commands

◎List of commands

Command	Operation	Parameter	Page No.
Ctrl+E Ctrl+E	Starting of Remote mode		103
E,BY	Ending of Remote mode		103
RMD	Setting of Remote Mode Condition	P1-P8	104
Ctrl+D, BREAK	Interruption of Operation		105
H	Display of Help List		106
N, DV	Selecting of Device Code	P1	107
OP,CP	Execution of COPY		108
Z,ER	Execution of ERASE		109
B,BL	Execution of BLANK		110
W,PG	Execution of PROG		111
V,VF	Execution of VERIFY		112
OT,CT	Execution of CONT		113
CK	Contact checking with a Device		114
SIG	Setting of ID Check	P1	115
MD, PAE	Specification of Operation Range of Device	P1-P3	116
S,DF	Setting of Transfer Data Format	P1	121
BLK	Writing difference	P1	123
BS	Display of Buffer memory Size		125
REV	Display of Firmware Version		126
L,LS	Display of Buffer Memory Data	P1.P2	127
BO,CS	SUM (4-digits)		128
BO8,CS8	SUM (8-digits)		129
F,INI	Buffer Initialaization	P1-P10	130
SCH	Data Searching:correspondence	P1-P10	131
UNS	Data Searching:Uncorrespondence	P1-P3	132
T	Transferring of Data	P1-P3	133
P,PL,WD	Serial I/F Data Output	P1,P2	134
RD	Serial I/F Data Input	P1,P2	135
RL	Serial I/F Data Input	P1-P3	136
WHO,MDL	Outputting of program name		137
PCH	Changing of protect setting	P1	138
WP	Serial I/F Protected information Output		139
RP	Serial I/F Protected information Input	P1,P2	140

Remarks : All commands should be in capital letter.

Ctrl + E Ctrl + E — Execution of Remote Mode —

The Remote Mode Operation is started.

COMMAND:

Ctrl+E Ctrl+E

or

ENQ(05h) ENQ(05h) code

Remarks: When **PROMPT** is set “#” or “#”   , “#” will be displayed on the display panel.

E,BY — Ending of Remote Mode —

The Remote Mode Operation is ended.

COMMAND:

E

or

BY

Parameters : none

RMD — Setting of Remote Mode condition —

You can change or check the remote mode setting.

COMMAND:

RMD, P1, P2, P3, P4, P5, P6, P7

◎Parameters

P1: ECHO Back	0: ON	1: OFF	
P2: PROMPT	0: #	1: #CR CL	2: none
P3: Time Out	0: OFF	1-FF: ---	(0 const)
P4: ACK/NAK	0: OFF	1: ON	
P5: Command Type	0: ---	1: M1900	(1const)
P6: Buzzer	0: ON	1: OFF	
P7: Dummy Read	0: ---	1: ON	(1const)

■Checking

```

RMD CR (LF)

SP 0 SP SP SP ECHO SP ON SP SP SP CR LF
SP 0 SP SP SP # SP SP SP SP SP SP SP CR LF
SP 0 SP SP SP TMO SP OFF SP SP SP CR LF
SP 0 SP SP SP ACK / NAK SP OFF CR LF
SP 1 SP SP SP M1900 SP mode SP CR LF
SP 1 SP SP SP BUZZER SP OFF SP CR LF
SP 1 SP SP SP PDM SP ON SP SP SP CR LF

PASS , RMD SP SP SP SP SP SP SP SP SP SP SP SP SP SP SP SP ; CR LF
    
```

■Changing

```

RMD , P1 , P2 , P3 P3 , P4 , P5 , P6 , P7 CR (LF)

PASS , RMD SP SP SP SP SP SP SP SP SP SP SP SP SP SP SP SP ; CR LF
    
```

The processing under present execution is interrupted and it changes into the state of the waiting for a command.

COMMAND:

Ctrl+D

or

BREAK code

Parameters : none

H — Displaying list of help —

Display the Remote command list.

COMMAND:

H

Parameters: none

H_{CR}(LF)

◎Example

```
*****
*   M189x remote command   *
*****
*** remote mode control ***
E,BY   : remote mode end      RMD    : remote config.
REV    : prom version display H    : help message display
BS     : buffer size display  ^D    : cancel command
break  : cancel command      ^E^E   : remote start
*** data in/out command ***
S,DF   : transfer format set  F,INI  : buffer mem initialize
P,PL,WD : serial output       RL,RD   : serial input
WP     : protect serial output RP    : protect serial input
*** unit execute command ***
OP,CP  : copy command         OT,CT   : cont command
B,BL   : blank command        V,VF   : verify command
W,PG   : program command      Z,ER   : EEPROM erase command
CK     : contact check command
*** other command ***
BO,CS  : check sum (4 figures) B08,CS8 : check sum (8 figures)
N,DV   : device select        PCH    : protect mode change
L,LS   : buffer mem display   T      : buffer mem transfer
SCH    : buffer mem search    UNS    : buffer mem un_search
```

```
P A S S , H SP SP SP SP SP SP SP SP SP SP SP SP SP SP SP SP SP SP SP SP SP ; CR LF
```

OP,CP —Executing COPY—

It carries out **COPY** operation on the remote mode.

COMMAND:

OP
or
CP

Parameters: none

Remarks: Both "**OP**" and "**CP**" carry out the same operation.

Normally, **COPY** enables to read data from #1 Device-socket only.

In case of "Set Prg mode" is set, copy socket is changed accordingly.

Reference : "Set Prg mode"(Applicable Operations)

Remarks : Make sure to excute "**CK**" command(Contact check with a Device) before "**OP**" and "**CP**" command execution.

Reference : "**CK**" (This chapter)

■ Execution

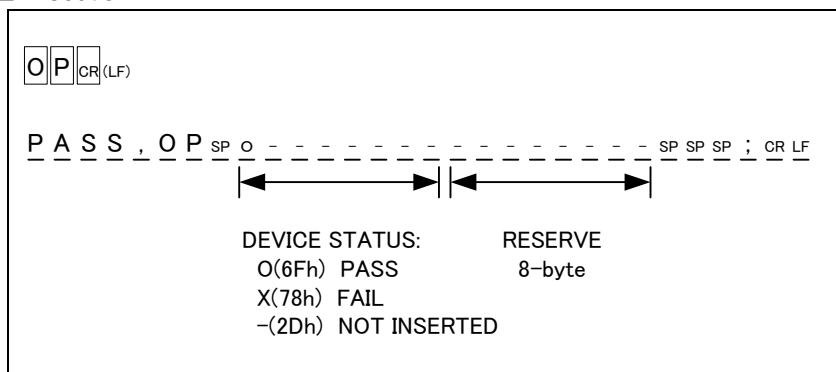

Remarks : This result becomes an error when Base unit is not installed or different types of units are installed.

And then, All of device status becomes '-'(2Dh).

Z,ER — Executing ERASE —

It carries out **ERASE** operation on the remote mode.

COMMAND

Z

or

E R

Parameters: none

Remarks : Both "Z" and "ER" carry out the same operation.

It is enabled when electric-erasable device(EE-PROM, FLASH,etc.) is selected.

Caution : Make sure to execute"CK"command(Contact check with a Device) before "Z"and "ER" command execution. **Reference : "CK"** (This chapter)

■Execution

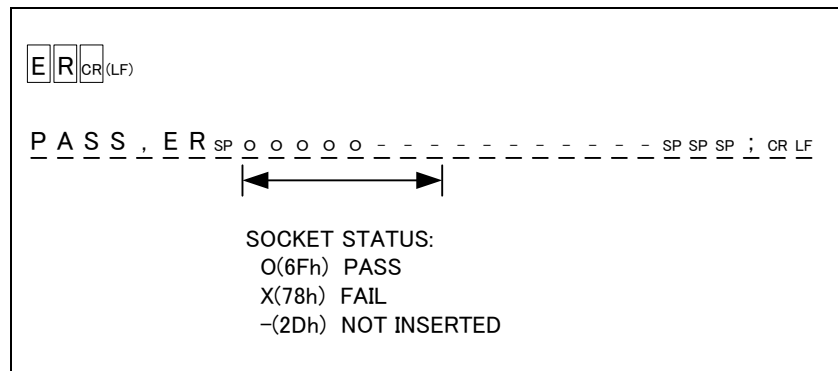

Remarks : The result becomes an error when Base unit is not installed or different types of units are installed.

And then, All of device status becomes'_'(2Dh).

B, BL — Executing BLANK —

It carries out **BLANK** operation on the remote mode.

COMMAND:

B

or

B L

Parameters: none

Remarks : Both "B" and "BL" carry out the same operation.

Caution : Make sure to execute "CK" command(Contact check with a Device) before "B" and "BL"

Reference : "CK" (This chapter)

■ Execution

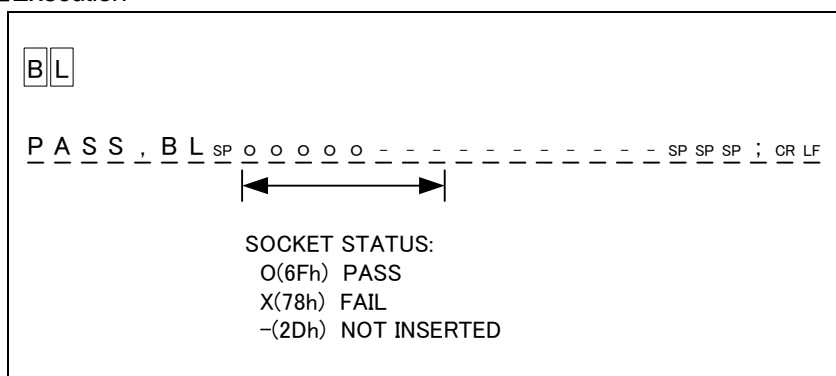

Remarks : The result becomes an error when Base unit is not installed or different types of units are installed.

And then, All of device status becomes '_(2Dh).

V,VF — Executing VERIFY —

It carries out **VERIFY** operation on the remote mode.

COMMAND:

V	
or	
V F	

Parameters: none

Remarks : Both "V" and "VF" carry out the same operation.

Caution : Make sure to execute "CK" command (Contact check with a Device) before "V" and "VF" command execution. **Reference : "CK"** (This chapter)

■ Execution

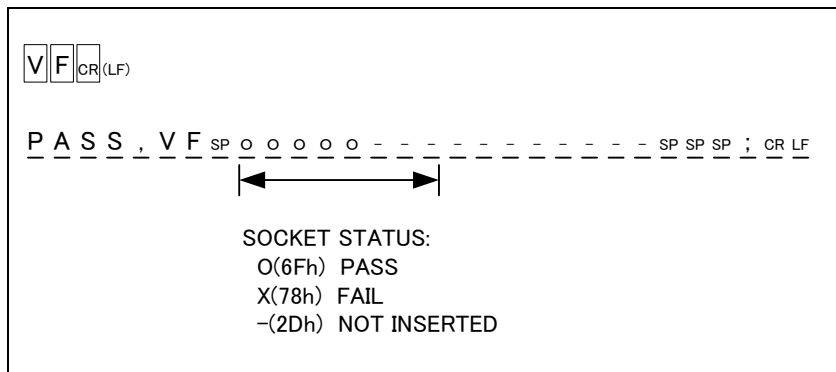

Remarks : The result becomes an error when Base unit is not installed or different types of units are installed. And then, All of device status becomes '_(2Dh).

It carries out **CONT** operation on the remote mode.

COMMAND:

O T
 or
C T

Parameters: none

Remarks : Both "OT" and "CT" carry out the same operation.

Caution : Make sure to execute "CK" command(Contact check with a Device) before "OT" and "CT" command execution. **Reference : "CK"** (This chapter)

Although the execution is interrupted temporarily and it asks for remove the FAIL device in case of panel operation when **BLANK** operation in **CONT** becomes FAIL at the panel operation. In case of remote mode the operation is not interrupted and it is continued at the remote operation.

That device will be judged as failure. **Reference : "CONT"** (Basic Operation)

■ Execution

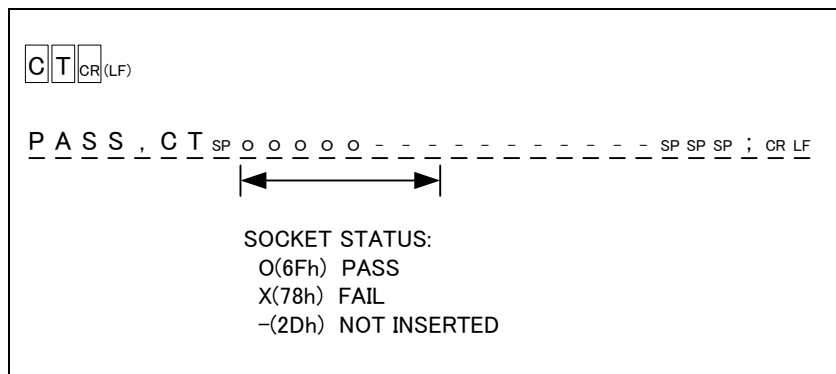

Remarks : The result becomes an error when Base unit is not installed or different types of units are installed. And then, All of device status becomes '_'(2Dh).

CK — Device contact check —

It carries out contact checking with a device on the remote mode.

COMMAND:

CK

Parameters: none

Caution : Before you execute commands such as "OP(COPY)", "BL(BLANK)" on the remote mode, make sure to carry out the contact checking with devices with this command and remove failure devices. then execute each command for operation.

■ Execution (at PASS End.)

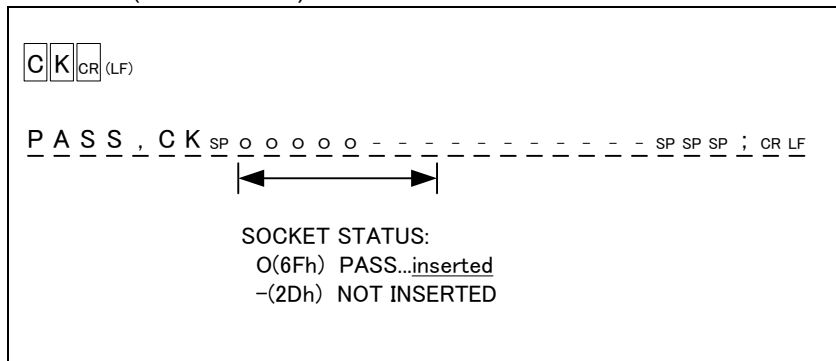

■ Execution (at FAILURE End.)

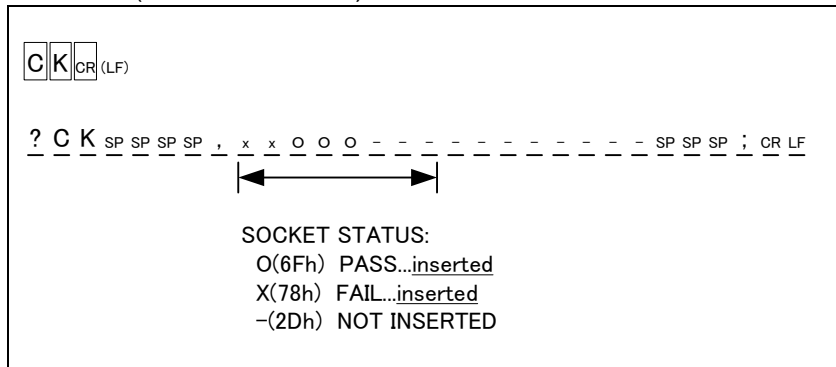

Remarks : The result becomes an error when Base unit is not installed or different types of units are installed. And then, All of device status becomes ' _ '(2Dh).

SIG - Setting of ID check -

This is to set either ON or OFF of ID Check function.

COMMAND

SIG,P1

Parameter:

P1 : ON,OFF

Remarks : When the remote mode is executed, the default setting is ON. Before the execution, the setting can be changed by key operation.

Setting	Function
0	OFF
1	ON

■Checking

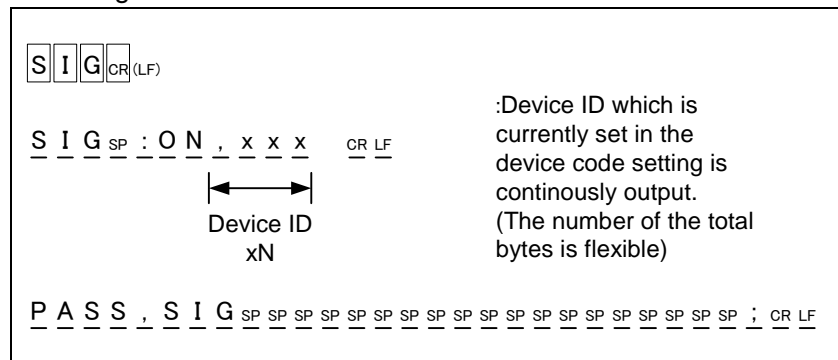

■Setting (When OFF is set)

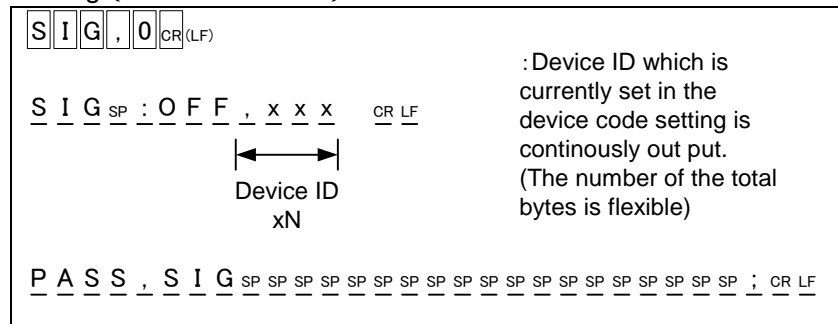

MD, PAE — Specifying device operating area —

It sets up or checks **PAE mode** on the remote mode.

COMMAND

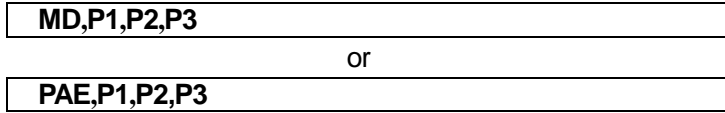

Parameters:

- P1 : Operation Start Address (Device)
- P2 : Operation End Address (Device)
- P3 : Operation Start Address (Buffer memory)

Remarks : Both “**MD**” and “**PAE**” carry out the same operation.

The setting that exceeds the address of the selected device cannot be set.

The setting that exceeds the address range of the buffer memory cannot be set.

→Reference:”**PAE mode**”(Applicable Operations)

■Checking

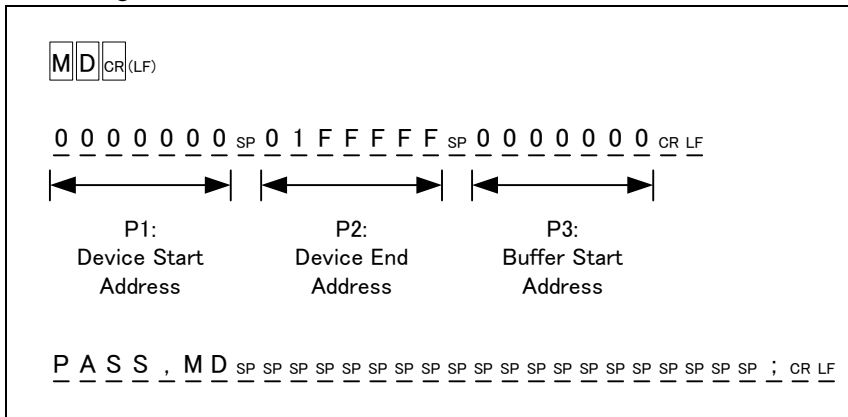

■Setting

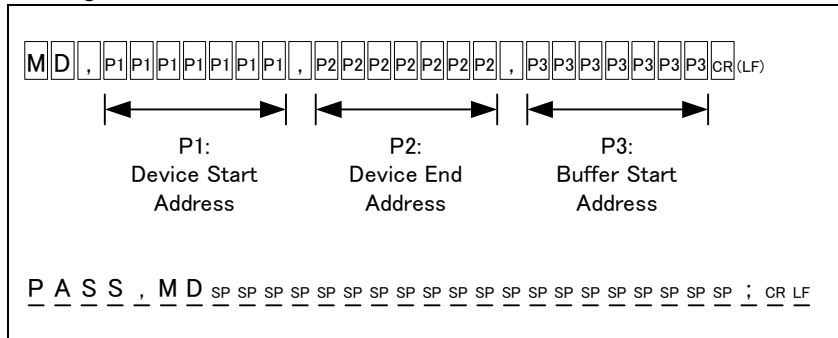

It resets PAE(return to default) by remote mode .

COMMAND:

MD, -, -, -

or

PAE, -, -, -

MD, DIS

or

PAE, DIS

Parameters: none

■Execution

M D , - , - , - CR (LF)

P A S S , M D SP ; CR LF

It sets up normal PAE mode by remote mode.

COMMAND:

MD, ENB

or

P A E , ENB

Parameters: none

■Execution

```
M D . E N B CR (LF)  
P A S S , M D SP SP SP SP SP SP SP SP SP SP SP SP SP SP SP SP SP SP SP SP SP SP ; CR LF
```

Remarks : Setting is note changed.

It sets up Mult PAE Mode by remote mode.

COMMAND:

MD, MLT

or

PAE, MLT

Parameters: none

Remarks: Program information is set up when mode is set by scanning memory.
In case program information is not set, F3 is displayed as error message.

■Execution

```
MD.MLT CR (LF)
PASS, MD SP SP SP SP SP SP SP SP SP SP SP SP SP SP SP SP SP SP SP SP SP ; CR LF
```

■Error message

```
MD.MLT CR (LF)
? MD SP SP SP SP . e F 3 SP SP SP SP SP SP SP SP SP SP SP SP SP SP SP SP ; CR LF
```

It displays setting of current PAE mode by remode mode.

COMMAND:

MD, MOD

or

P A E , M O D

Parameters: none

Remarks:

(Example) DIS : Normal mode
ENB : Previous Single PAE mode
MLT 2 : Multi PAE mode (Programming)

■ Execution

```
P A E . M O D CR (LF)
D I S SP SP SP SP SP SP SP SP SP SP SP SP SP SP SP SP SP SP SP SP SP ; CR LF
P A S S , M D SP SP SP SP SP SP SP SP SP SP SP SP SP SP SP SP SP SP SP SP SP ; CR LF
```

S, DF — Setting data format for transfer —

It sets up or checks **Data Format** on the remote mode.

COMMAND:

S, P1

or

DF, P1

Parameters: P1 Data Format Number 2-digits

Remarks: Both “S” and “DF” carry out the same operation.

→Reference:”Data Format”(Memory)

■Format List

P1(hex)	Data Format
00:	MINATO HEX
01:	————
02:	INTEL HEX
03:	HP64000 ABS
04:	————
05:	MOTOROLA S
06:	————
07:	————
08:	————
09:	————
10:	————
11:	————
12:	————
13:	————
14:	No Format

Remarks: “————” means an error.

■Checking

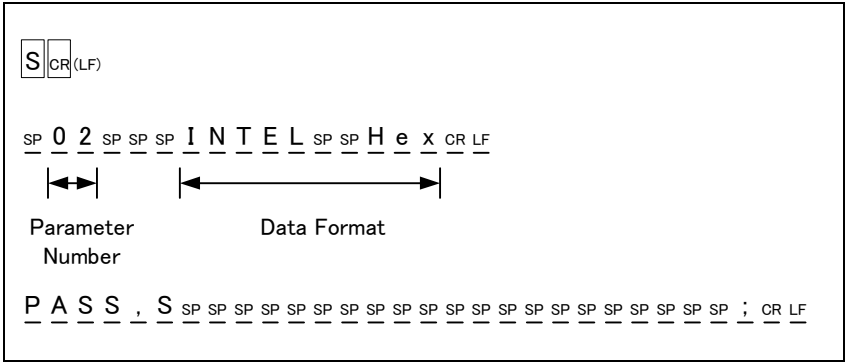

■Setting

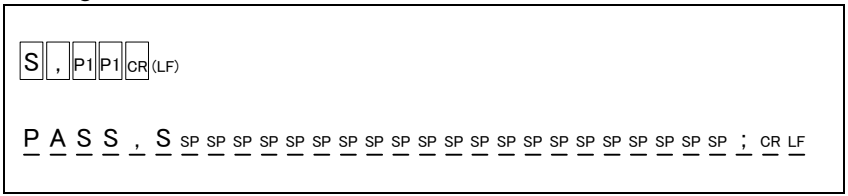

BLK — Programming different data in multiple device —

It sets or checks **Set Prg mode** on the remote mode.

COMMAND:

BLK, P1

Parameters: P1 Mode Number 2-digits

Remarks : A default mode when 8-bits device is selected will be "01"

A default mode when 16-bits device is selected will be "11"

When changing a device code setting or turning power on/off. the setting will be set as default.

©Mode List

Number	Set mode (Data Width x Blocks)	Data Width of The Selected device
00	_____	8bit
01	8bit x1	
02	8bit x2	
03	8bit x4	
04	8bit x8	
05	16bit x1	
06	16bit x2	
07	16bit x4	
08	32bit x1	
09	32bit x2	
0A	_____	16bit
0B	_____	
10	_____	
11	16bit x1N	
12	16bit x2N	
13	16bit x4N	
14	16bit x8N	
15	32bit x1N	
16	32bit x2N	
17	32bit x4N	
18	_____	_____
Others	_____	

Remarks: "-----" means an error.

■Checking

```

BLK CR (LF)

BLOCK _ MODE SP 0 1 : SP SP 8 B I T x 1 SP SP CR LF
      |<>|
      Parameter
      Number

PASS , BLK SP SP SP SP SP SP SP SP SP SP SP SP SP SP SP SP SP ; CR LF
  
```

■Setting

```

BLK , P1 P1 CR (LF)

PASS , BLK SP SP SP SP SP SP SP SP SP SP SP SP SP SP SP SP SP ; CR LF
  
```

A firmware version for M1896 is outputted to the external equipment.

COMMAND:

```
REV
```

Parameters: none

■ Execution

```
REVCR(LF)  
  
SP V SP 1 . 0 0 a CR LF  
  
P A S S , R E V SP SP SP SP SP SP SP SP SP SP SP SP SP SP SP SP SP SP SP SP SP ; CR LF
```

L,LS — Displaying Buffer memory Data —

Buffer memory data is outputted to the external equipment. A output address range can be selected.

COMMAND:

L, P1, P2

or

L S, P1, P2

Parameters:

P1: Output Start Address (Buffer Memory)

P2: Output End Address (Buffer Memory)

Remarks : Both “L” and “LS” carry out the same operation.

The setting that exceeds the address range of the memory cannot be selected.

■Example (Outputting datas that is initialized with “03,06,0C...”)

Operating range: 0-FFh

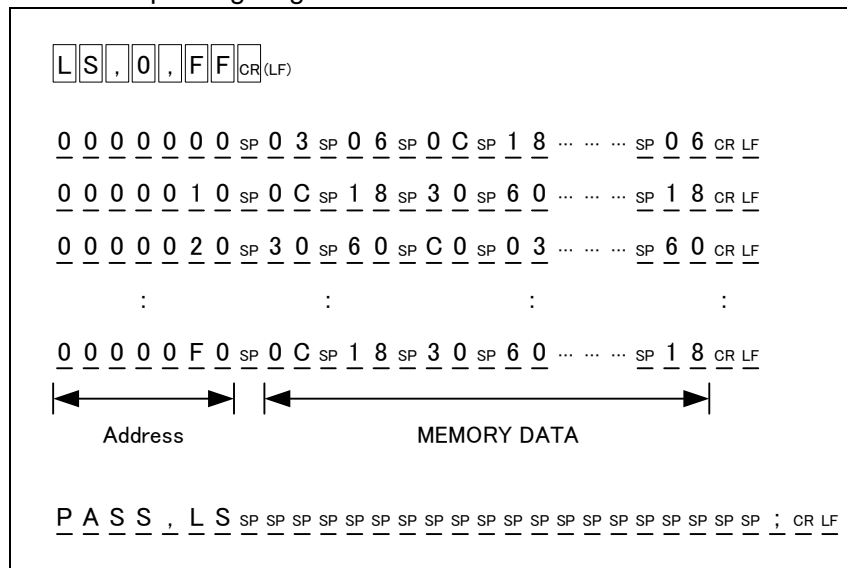

BO,CS — Add 4-digits—

The data sum in the buffer memory that is calculated with the address range of present setting (**PAE**) is outputted to the external equipment in 4-digits.

COMMAND:

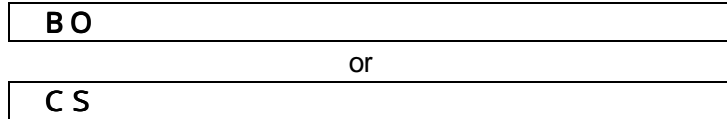

Parameters: none

Caution : In general, **PAE mode** is enabled, but that is disabled during **Set Prg mode**.

Remarks : Both “**BO**” and “**CS**” carry out the same operation.

■Output

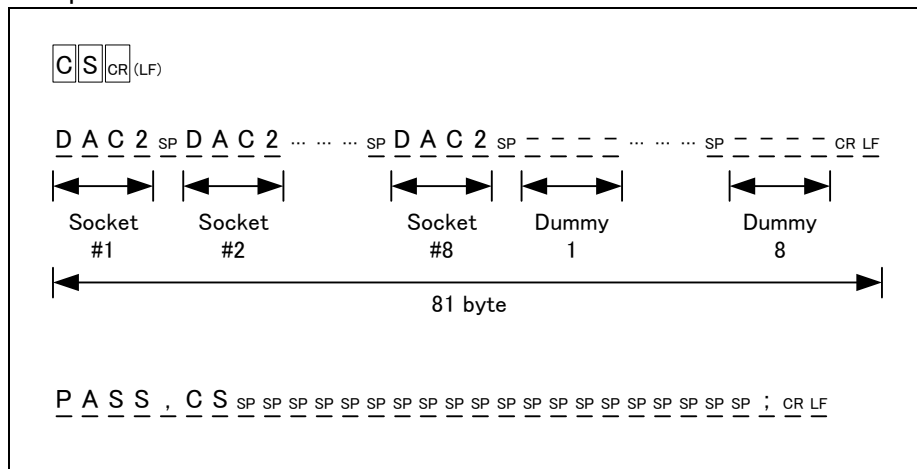

Remarks : Sums are outputted every each socket. And dummy datas”-“ for additional 8 sockets will be outputted continually after sums as sockets #1-#8 is outputted. This is for a compatibility with our other programmers.

BO 8, CS 8 — Add (8-digits) —

This data sum in the buffer memory that is calculated with the address range of present setting(PAE) is outputted to the external equipment in 8-digits.

COMMAND:

BO 8

or

CS 8

Parameters: none

Caution : This command is not valid for “Set Prg mode”(BLK command), as the command carries out calculating the data sum of buffer memory with address range of only#1 device socket.

**Please use commands”BO” or “CS” when this mode is setted up.
PAE setting is enabled.**

Remarks : Both “**B08**” and “**CS8**”carry out the same operation.

■ Example

```
C S 8 CR(LF)
3 6 6 D B 6 A 8 CR LF
P A S S , C S 8 SP SP SP SP SP SP SP SP SP SP SP SP SP SP SP SP SP SP ; CR LF
```

F,INI — Initializing buffer memory data —

It initializes the buffer memory. You can set a certain initializing data in repeatable pattern with maximum 8-bytes. An address range of the buffer memory can be set.

COMMAND:

F, P1, P2, P3, P4, P5, P6, P7, P8, P9, P10

or

INI, P1, P2, P3, P4, P5, P6, P7, P8, P9, P10

Parameters:

P1 : Initialize Start Address (Buffer Memory)
 P2 : Initialize End Address (Buffer Memory)
 P3-10 : Initialize Data

Default Values(hex):

P1 : 00
 P2 : 1FFFFFF (with 32M-bytes buffer memory)
 P3-P10 : FF

Remarks: Both "F" and "INI" carry out the same operation.

The setting that exceeds the address range of the buffer memory cannot be set.

■ Setting

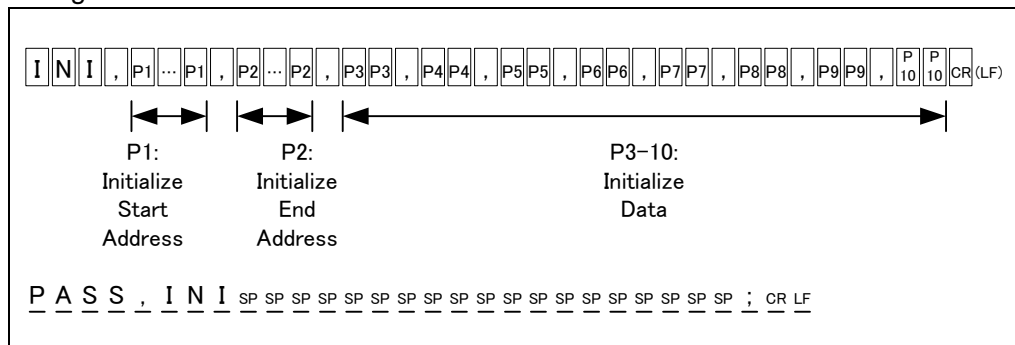

Example 1) Initialize all the buffer memory data with "FF"

COMMAND: INI, , , FF CR

Example 2) Initialize all buffer memory data with "03,06,... "pattern.

COMMAND: INI, , , 03, 06, 0C, 18, 30, 60, CO CR

SCH — Data Searching: Correspondance -

After searching a certain line of data(max 8-byte) in the buffer, the result is output.

Buffer start address, end address,data line can be set.

When the targeted data line is a found in the buffer, the address is displayed.

When no match is found, the very next of the end address is displayed.

COMMAND:

```
S C H , P 1 , P 2 , P 3 , P 4 , P 5 , P 6 , P 7 , P 8 , P 9 , P 10
```

Parameters:

P1 : Search Start Address (Buffer Memory)
P2 : Search End Address (Buffer Memory)
P3-10 : Search Data (1byte)

Default Values(hex) :

P1 : 00
P2 : 1FFFFFFF (with 32M-bytes buffer memory)
P3-10 : FF

Remarks: The setting that exceeds the address range of the buffer memory cannot be set.

■ Searching

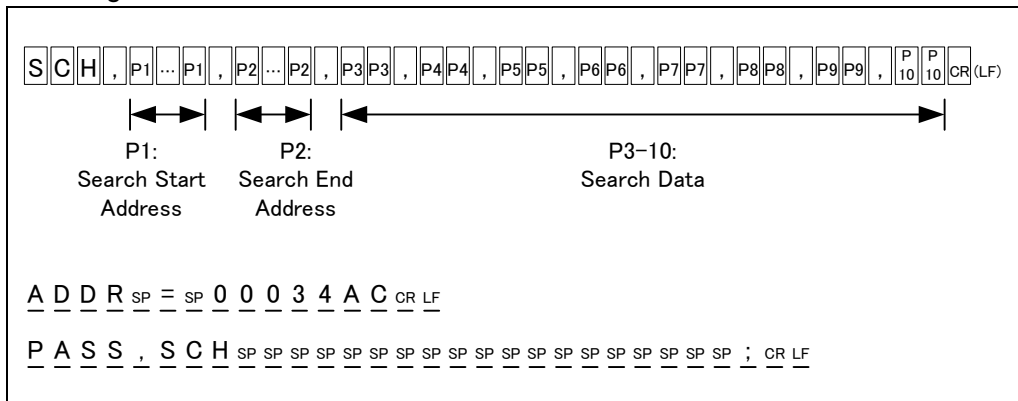

UNS — Data searching: Uncorrespondance —

Certain data (maximum 1-bytes) on the buffer memory is checked by un-correspondant search and the result is output. A start and end address of the buffer memory and a data for searching can be set. When there is a un-correspondant data on the buffer memory, the un-correspondant address will be displayed on the display panel. The next of the end address for searching will be displayed when no match is found.

COMMAND:

```
UNS, P1, P2, P3
```

Parameters:

- P1 : Search Start Address (Buffer Memory)
- P2 : Search End Address (Buffer Memory)
- P3 : Search Data (1-byte)

Default Values(hex):

- P1 : 00
- P2 : 1FFFFFF (with 32M-bytes buffer memory)
- P3 : FF

Remarks: The setting that exceeds the address range of the buffer memory cannot be set.

■ Searching

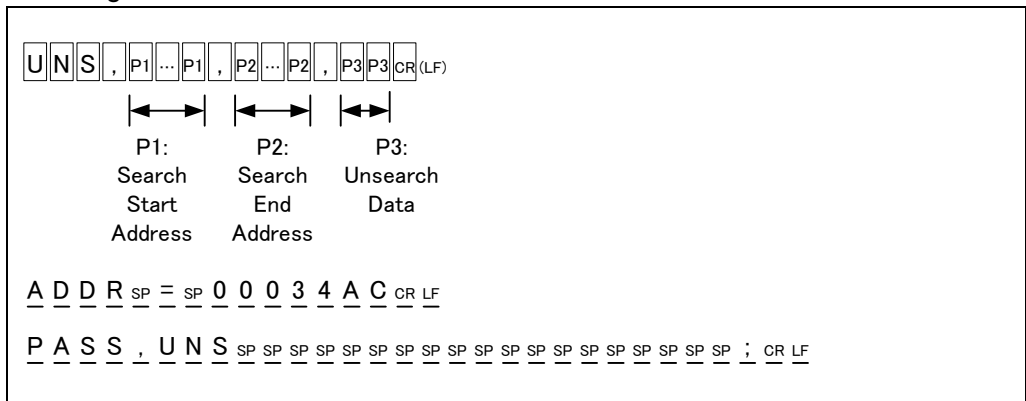

T — Tranfering Data —

It copies datas of certain address range of the buffer memory and transfers it to other address space. A start and end address for coping and the destination address of the buffer memory can be set.

COMMAND:

T, P1, P2, P3

Parameters:

P1 : Copy Start Address (Buffer Memory)
 P2 : Copy End Address (Buffer Memory)
 P3 : Destination Address (Buffer Memory)

Default Values(hex) :

P1 : 00
 P2 : 00
 P3 : 00

Remarks: The setting that exceeds the address range of the buffer memory cannot be set.

■ Execution

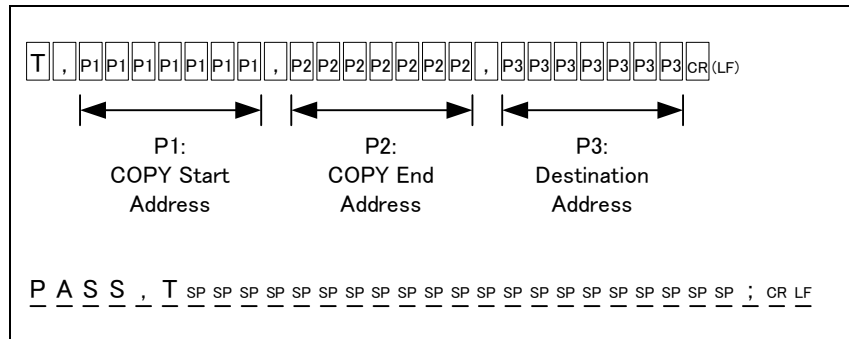

Remarks: Data beyond buffer address can not be transferred.

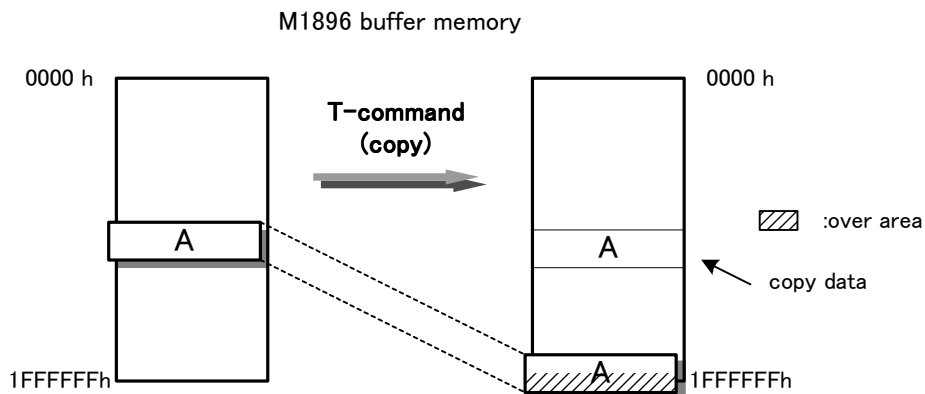

P , PL , WD — Serial I/F Data output —

It carries out the data outputting for Serial I/F(RS232C) on the remote mode.

After transforming datas of the buffer memory according to **Data Format(S or DF)** commands, the formatted data will be outputted.

A start and end address of the buffer memory can be set.

COMMAND:

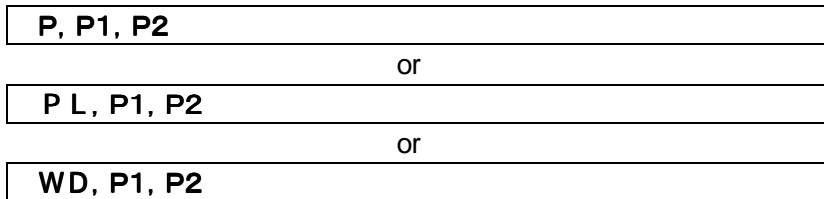

Parameters:

P1 : Transmission Start Address (Buffer Memory)

P2 : Transmission End Address (Buffer Memory)

Default Values(hex) :

P1 : 00

P2 : 1FFFFFF

Remarks : The setting that exceeds the address range of the buffer memory cannot be set.

Both "P", "PL" and "WD" carry out the same operation.

Example Output datas of the buffer memory initialized with "03,06,0C,...".

Address range:00-0Fh, Format "INTEL hex"

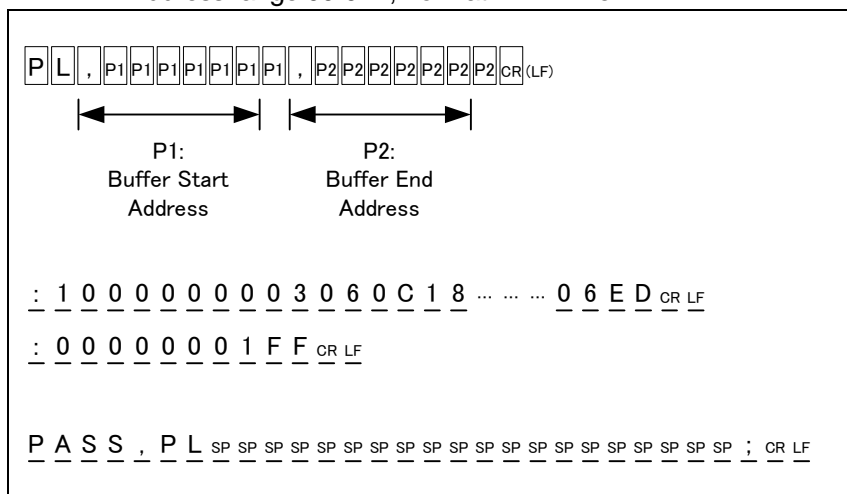

RD — Serial I/F Data input —

It carries out the data inputting for Serial I/F(RS-232C) on the remote mode.

At first, M1896 changes Serial I/F into a state of the waiting for a formatted data inputting when receiving **RD** command, and then data will be stored in the buffer memory according to the setting of **Data Format(S or DF commands)**.

A start and end address of the formatted data for inputting can be set.

COMMAND:

RD, P1, P2

Parameters:

P1 : Formated Data Start Address (Formated Data)
 P2 : Data Store Start Address (Buffer Memory)

Default Values (hex):

P1 : 00
 P2 : 00

Remarks: The setting that exceeds the address range of the buffer memory cannot be set.

Caution : Data cannot be loaded only with **RD** command input. In addition to that, it is necessary to transmit the formatted data from the external equipment to M1896.

■Receiving

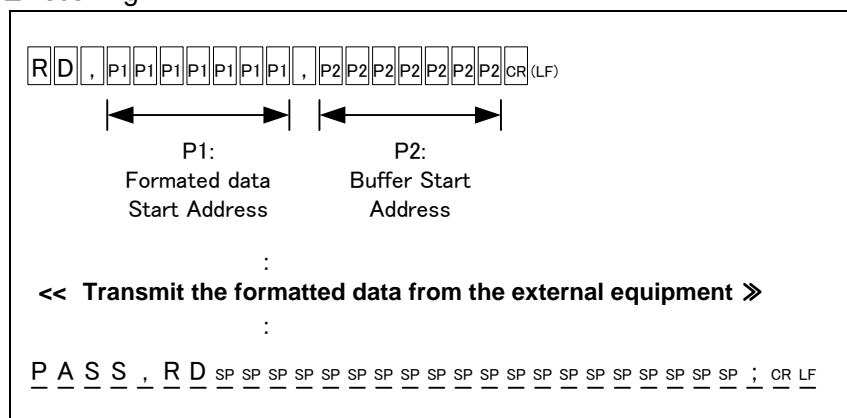

RL — Serial I/F Data Input —

It carries out the data inputting for Serial I/F(RS232C) on the remote mode.

At first, M1896 changes Serial I/F into a mode for data input.

Once data is received, the data is converted according to **Data Format (S,DF-com)** and stored in the buffer memory.

A start and end address of the formatted data for inputting and start address of the buffer memory for storing can be set.

COMMAND:

R L, P1, P2, P3

Parameters:

P1 : Formated Data Start Address (Formated Data)
P2 : Formated Data End Address (Formated Data)
P3 : Data Store Start Address (Buffer Memory)

Default Values(hex) :

P1 : 00
P2 : 1FFFFFF (with 32M-bytes buffer memory)
P3 : 00

Remarks: The setting that exceeds the address range of the buffer memory cannot be set.

Caution : Data cannot be loaded only with **RD** command input. In addition to that, it is necessary to transmit the formatted data from the extrenal equipment to M1896.

■Receiving

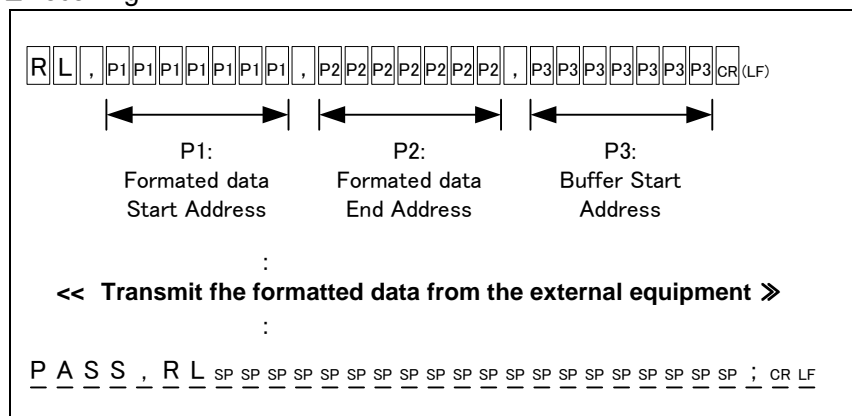

WHO,MDL — Output programmer model name —

It is checked programmer model name by remote mode.

COMMAND

WHO

or

MDL

Parameters: none

Remarks: " WHO " , " MDL " is same operation.

This command is effective by Handler etc.

■ Execution

```
WHO CR(LF)
M 1 8 9 6 CR LF
P A S S , W H O SP SP SP SP SP SP SP SP SP SP SP SP SP SP SP SP SP SP SP SP SP ; CR LF
```

PCH — Changing Protect mode —

It sets or checks **Protect Setting** on the remote mode.

COMMAND:

PCH, P1

Parameters: P1 Protect Mode Number

Remarks: When changing a device code setting or timing power on/off, the setting will be set as default.

■ Mode List

P1 (hex)	Protect Mode
0:	No operation
1:	Unprotect/Protect
2:	Protect Only

■ Checking

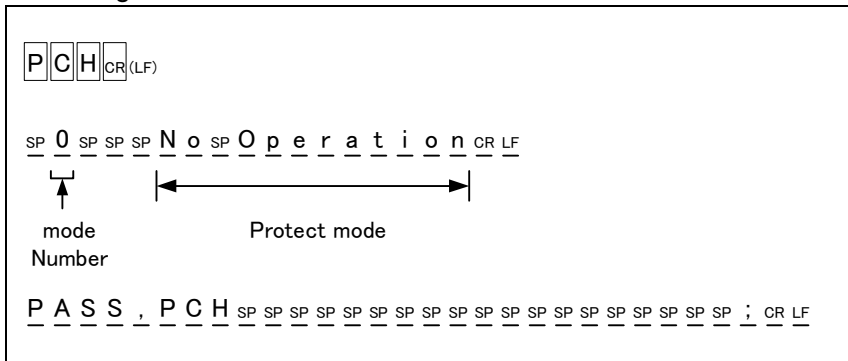

■ Setting

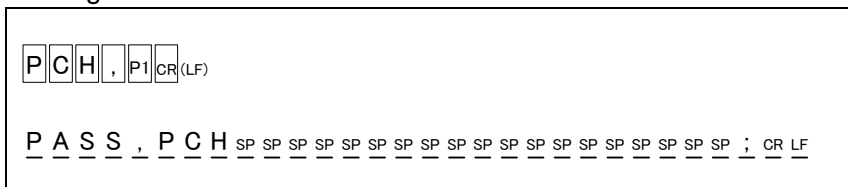

WP — Serial I/F protected data Output —

It carries out the data outputting of the protected information for Serial I/F(RS232C) on the remote mode. After transforming data of the protected information according to the setting of **Data Format(S or DF** commands), the formatted data will be outputted to the external equipment.

COMMAND:

WP

Parameters: none

Remarks: Each information of the protection or unprotection will be shown,"01","00".

■Example No.0-1:Protection, others:Unprotection(of 7 areas)

Data Format:INTEL_FORMAT

```
WP CR(LF)
: 0 7 0 0 0 0 0 0 0 1 0 1 0 0 0 0 0 0 0 0 0 0 F 7 CR LF
  SECTOR: [0] [1] [2] [3] [4] [5] [6]
: 0 0 0 0 0 0 0 1 F F CR LF
P A S S , W P SP SP SP SP SP SP SP SP SP SP SP SP SP SP SP SP SP SP SP ; CR LF
```

RP — Serial I/F Protected data input —

It carries out the data inputting of the protected information through Serial I/F (RS232C) on the remote mode. At first, M1896 changes Serial I/F into a mode for a formatted data input when receiving **RP** command. Once data is received, the data is converted according to **Data Format (S or DF)** commands and stored.

A start and end address of the formatted data for inputting can be set.

COMMAND:

RP, P1, P2

Parameters:

P1 : Formated Data Start Address (Formated Data)

P2 : Formated Data End Address (Formated Data)

Default Values(hex) :

P1 : 00

P2 : (The value depending on the selected device will be set.)

Remarks: When changing a device code setting or turning power on/off, the setting will be set as default.

■Receiving

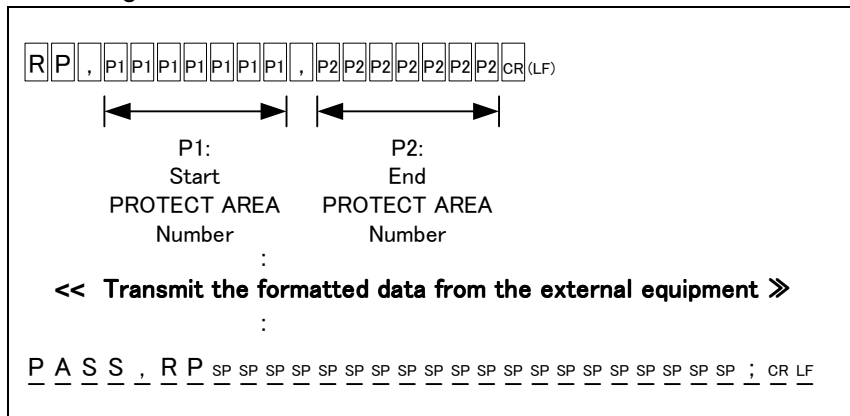

MAINTENANCE

Error message	142
Error message during self-test	142
Error message during operation	143
Error message during remote mode	143
After service	144
User maintenance of device programmers and adapters	144
Specification	145
Specification of M1896	145
Specification of connector(RS232C)	146
Specification of connector (USB)	147
Head quarter	148

Maintenance

ERROR MESSAGE

◎Error message during self-test

Error indication	Corrective actions
"FPGA Config Error !! "	
" FPGA Func Error !! "	
" FPGA SUM/XOR Error "	
" SELF CHECK ERROR !! " [xxxxx]	
"!! Vcc SW Error !! "	Check the device socket.
"!! Vpp SW Error !! "	Check the device socket.
"!! Vhh SW Error !! "	Check the device socket.
"DATA_Read Error X.Xv"	Check the device socket.
" Verify Error X.Xv"	Check the device socket.
" PRG_Very Error X.Xv"	Check the device socket.
" SET_Very Error X.Xv"	Check the device socket.
"Pull up/down Error "	Check the device socket.
"Memory check Error !"	

In case of irregular operation occurs

(No buzzer sounds.)	
(Nothing is indicated on the display)	
(No LED is lighted.)	

When any of the above error occurred, make sure that no foreign item(including socket adapter) is placed on the device Sockets.

Press the RESET key to execute the self-check again from the beginning.

When error still occurs, please contact to Minato authorized distributor.

◎Error message during operation

Error indication	Error Overview	Corrective actions
“Empty socket”	There is any device socket in which a device has not been set. Red LED is lit on the corresponding socket.	Check the device-sockets.
“ !! OVER CURRENT !!”	Too much current is applied to the device lcc. Red LED is lit on the corresponding socket.	Remove failure devices.

◎Error message during remote mode

Error code	Error	Error overview
9 0	Check Sum Error	Error during Formated Data Transfer
9 1	Format Error	Error during Formated Data Transfer
F 0	Illegal Command	Error when the illegal command is inputed
F 1	Parameter Error	Parameter mismatch
F 2	Invalid Function	Error when the invalid function is executed (Such as executing ERASE with EPROM device)
F 3	Multi PAE mode Error	Error when MULTI PAE is set (All buffer memory is FF of error when MULTI PAE is set)

After service

The warranty period of this unit is for one year after the shipment from Minato. Even during the warranty period, we exclude damage as a result of natural disaster, misoperation, modification or change of the unit by user and wear of the device socket from the warranty.

Also, Please note that we are not obliged to refund for a damaged P-ROM when this unit gets out of order. In case of anything unclear to you, please contact Minato authorized distributor that you purchase this unit.

User maintenance of device programmers and adapters

1. Do not keep programmer in dusty and/ or humid area . That may cause a damage on the unit.
When adapters are used in humid area, that may cause to transfer remaining chemicals from the pins of the devices to the contact of the socket adapters.
Please be aware that chemical reaction and dusts may shorten the life of the adapters.
- 2 . The adapters and Textool are consumable items. When the rate of programming failure is increased that could be a time for you to replace them. Please consult with your local Minato distributor for detail.
- 3 . To clean sockets, please use only air to blow dusts on the sockets. Do not use a contact cleaner that may gather dusts on the contact of the socket adapters.

Specification

Specification of M1896

Operating Temperature

5-35 ()

Power Supply

100-240VAC (50/60Hz)
0.9A at 100VAC, Ta=25 (max)

Dimensions

Width	380	(mm)
Depth	297	(mm)
Height	100	(mm)

Weight

5 (Kg)
(6.5) (kg) Base unitx4 mounted

Display

Liquid crystal display panel of 20characters x 4 lines
2-color LED lamp Suitable to each socket

Buffer memory

256Mbits	(Standard)
1 Gbits	(Maximum)

External Interface (Serial Interface)

: RS232C
: USB

Quantity of program device

1 ~ 16pcs simultaneously

Attached socket unit

SU816 x 4sets
(Unit for 8bit/16bit device)
1 Unit is attached 1 socket for 8bit device and another socket for 16bit device.

◎

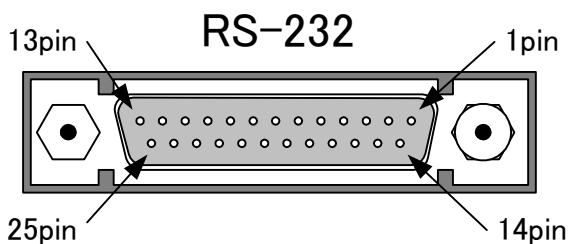

conector
:DSUB25-socket
:DBLC-J25SAF-23L9F (JAE)

◎PIN Arrangement List (DCE)

PIN No.	Singal name	Direction	Explanation of Fuction
1	FG	-	Frame GND
2	TXD	Ex-equipment → M1896	
3	RXD	Ex-equipment ← M1896	
4	RTS	Ex-equipment → M1896	
5	CTS	Ex-equipment ← M1896	
6	DSR	Ex-equipment ← M1896	
7	SG	-	Signal GND
8	CD	Ex-equipment ← M1896	
20	DTR	Ex-equipment → M1896	
22	RI	Ex-equipment ← M1896	

◎ Example of Connection (M1896~PC/AT)

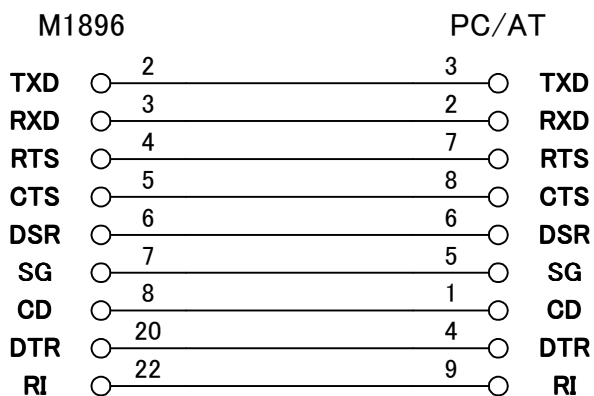

©Pin Arrangement

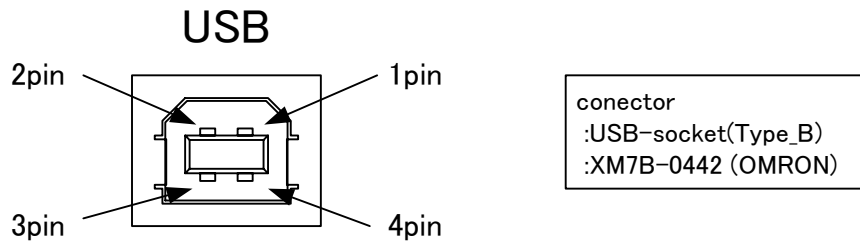

©Pin Arrangement List (DCE)

Pin No.	Signal name	Explanation of Function
1	VBUS	Power Supply
2	D-	Data
3	D+	Data
4	GND	Signal GND

Warning : One set of PC can be connected to M1896.

USB 1,1 standard cable is recommended.

MINATO ELECTRONICS INC.

JAPAN
MINATO ELECTRONICS Inc.
4105 Minami Yamada-Cho Tsuzuki-ku,
Yokohama-Shi 224-0026 JAPAN

Tel: +(81)45-592--5549
Fax: +(81)-45-592-2854
Web: www.minato.co.jp